

# Task Load Estimation for ATC Ground Control

## A Dynamic Density-based Analysis

Master of Science Thesis

Stijn Brunia





# Task Load Estimation for ATC Ground Control

A Dynamic Density-based Analysis

by

Stijn Brunia

to obtain the degree of Master of Science  
at the Delft University of Technology,  
to be defended publicly on the 17th of July.

Student number: 4549643  
Project duration: April 2022 – July 2023  
Thesis committee: Dr. Bruno Santos  
Dr. Alexei Sharpanskykh  
Ir. Olaf Stroosma  
Drs. Marian Schuver

An electronic version of this thesis is available at <http://repository.tudelft.nl/>.



# Preface

This thesis reports on my research for obtaining a Master of Science Degree in Aerospace Engineering at Delft University of Technology. The research focuses on a technical data-based analysis of the ground control system at Schiphol Airport and especially the influence of the traffic load on the task load of the controllers.

This research has been a very educational and very challenging part of my studies. It gave me the opportunity to focus more on linking data with real-world operations, which was so interesting that I am starting a job within that field. On the challenging aspect, I was lucky enough to have two great supervisors, Alexei Sharpanskykh and Marian Schuver, who I could always trust to help me when necessary and who always showed honest interest in the research I performed. Next to this, I would like to thank Ferdinand Dijkstra, Ron Guis, Cornel van Ravenswaaij and Justin The, who all made an important contribution to this research. Ron and Cornel especially shared important insights into the world of ground control at Schiphol Airport, without which this research would not have been possible.

Of course, I would also like to thank my girlfriend, family and friends for creating welcome distractions and being there along the way, not only for this research but through my entire education in Delft. It has been seven great years which are concluded by this research, and I am looking forward to the next phase, I am sure they will be great as well.

Stijn Brunia  
Delft, July 2023



# Contents

List of Figures	vii
List of Tables	ix
<b>I Scientific Paper</b>	<b>1</b>
<b>II Literature Study</b>	<b>21</b>
<b>previously graded under AE4020</b>	
<b>1 Introduction</b>	<b>23</b>
<b>2 Schiphol Airport Operations</b>	<b>25</b>
2.1 Schiphol Airport . . . . .	25
2.2 Runway capacity & configurations. . . . .	26
<b>3 Ground Control at Schiphol Airport</b>	<b>31</b>
3.1 Controller responsibilities and goals . . . . .	31
3.2 Sectors. . . . .	33
3.3 Controller workplace . . . . .	34
<b>4 Task load</b>	<b>39</b>
4.1 Workload and task load definition . . . . .	39
4.2 Task load data . . . . .	40
4.3 Experiment . . . . .	41
<b>5 Dynamic Density</b>	<b>47</b>
5.1 Concept . . . . .	47
5.2 Previous Research . . . . .	48
5.3 Research Gap . . . . .	50
5.4 Dynamic Density for Ground Control . . . . .	50
<b>6 Regression Analysis</b>	<b>57</b>
6.1 Correlation Analysis . . . . .	57
6.2 Regression analysis . . . . .	61
<b>7 Research Plan</b>	<b>65</b>
7.1 Project Objective & Research Questions . . . . .	65
7.2 Project Planning . . . . .	66
<b>8 Conclusion</b>	<b>69</b>
<b>III Supporting work</b>	<b>71</b>
<b>1 Ground Control at Schiphol Airport</b>	<b>73</b>
1.1 Controller responsibilities and goals . . . . .	73
1.2 Sectors. . . . .	75
1.3 Controller workplace . . . . .	76
1.4 Experiment . . . . .	80
<b>2 Ground Control at Schiphol Airport</b>	<b>85</b>
2.1 Controller responsibilities and goals . . . . .	85
2.2 Sectors. . . . .	87
2.3 Controller workplace . . . . .	88
2.4 Experiment . . . . .	92

<b>3</b>	<b>Figures</b>	<b>97</b>
	<b>Bibliography</b>	<b>99</b>

# List of Figures

2.1	Ground operations Aircraft flow [26]	25
2.2	Runways Schiphol Airport [48]	26
2.3	Lay-out Schiphol Airport [45]	26
2.4	Schiphol Airport Windrose [18]	27
2.5	Configuration Rank based on occurrence	29
2.6	Configuration Rank based on duration	29
3.1	Ground Control Sectors [41]	33
4.1	BlueSky Experiment Visualisation	43
1.1	Ground Control Sectors [41]	76
1.2	BlueSky Experiment Visualisation	82
2.1	Ground Control Sectors [41]	88
2.2	BlueSky Experiment Visualisation	94
3.1	EHAM Movement Chart [45]	98



# List of Tables

5.1	Suggested dynamic density parameters . . . . .	52
8.1	Suggested dynamic density parameters . . . . .	70



# Acronyms

<b>04/22</b>	Schiphol East Runway.
<b>06/24</b>	Kaag Runway.
<b>09/27</b>	Buiterveldert Runway.
<b>18C/36C</b>	Zwanenburg Runway.
<b>18L/36R</b>	Aalsmeer Runway.
<b>18R/36L</b>	Polder Runway.
<b>ACC</b>	Area Control Centre.
<b>APC</b>	Apron Planning & Control.
<b>ASDE</b>	Airport Surface Detection Equipment.
<b>ASTRA</b>	Airport Surveillance Tracker.
<b>ATC</b>	Air Traffic Control.
<b>ATWIT</b>	Air Traffic Workload Input Technique.
<b>CTR</b>	Control Zone.
<b>FAA</b>	Federal Aviation Administration.
<b>IFR</b>	Instrument Flight rules.
<b>IMC</b>	Instrumental Meteorological Conditions.
<b>LVNL</b>	Air Traffic Control the Netherlands.
<b>OE</b>	Operational Experts.
<b>OPL</b>	Outbound Planning.
<b>R/T</b>	Radio Telephony.
<b>RC</b>	Runway Controller.
<b>SID</b>	Standard Instrument Departure.
<b>SUP</b>	Tower Supervisor.
<b>TMA</b>	Terminal Maneuvering Area.
<b>TWR</b>	Schiphol Tower Control.
<b>TWR ASS-2</b>	Tower Assistent 2.
<b>TWR-C</b>	Schiphol Tower Center.
<b>TWR-W</b>	Schiphol Tower West.
<b>VMC</b>	Visual Meteorological Conditions.
<b>WJHTC</b>	William J. Hughes Technical Center.



# I

Scientific Paper



# Task Load Estimation for ATC Ground Control

## A Dynamic Density-based Approach

Stijn Brunia,\*

Delft University of Technology, Delft, The Netherlands

### Abstract

Increasing runway capacity is a key objective for many airports worldwide, including Schiphol Airport. One of the restricting factors that has become more prevalent throughout the years lies in the task load of the Air Traffic Ground Controllers. To overcome this limiting factor, it becomes essential to mitigate this high task load. This study proposes a methodology for estimating ground controller task load at Schiphol Airport, which is used for analyzing the effectiveness of a mitigation method employed at Schiphol Airport, namely the splitting of the combined North-Centre sector. To achieve this, the research adopts the concept of task load estimation via dynamic density modelling, which has primarily been explored when applying it to the airborne segments of Air Traffic Management. The task load estimation models for the different ground control sectors are developed through a multi-phase approach encompassing data collection, candidate independent variable selection, a double correlation analysis, and a sequential search regression for model building. The research successfully constructed task load estimation models for four out of the five analysed sectors. Furthermore, two of these models are employed in a case study to evaluate the task load reduction strategy. The findings highlight that splitting the combined North-Centre sector to alleviate the task load experienced by the North sector ground controller can be an effective mitigation strategy, particularly when the Centre sector experiences a significant level of traffic load.

## 1 Introduction

Air traffic management (ATM) is a complex field where the workload of air traffic controllers (ATCOs) can have a significant impact on the capacity of the airspace or airport. While extensive research has been conducted on the task load of ATCOs in airborne segments of ATM, there has been a lack of research on the grounded segments. At Schiphol Airport, the task load faced by ground controllers is a crucial factor in the complexity of handling ground traffic, which in turn influences the overall airport capacity. This study proposes a methodology based on the principle of Dynamic Density to estimate the task load of ground controllers at Schiphol Airport. The application of this methodology is illustrated through a case study.

A number of definitions of task load have been used throughout the literature. The general consensus sees task load as the part of the mental workload that is purely induced by the task demand, and which is therefore performer independent. [20, 6, 2] When applying this to ATM the task load is often seen as being heavily induced by the traffic complexity. [18, 14] When estimating task load within this study, the focus will therefore lay on the traffic controlled by the ATCOs.

The responsibilities of the ground controller are to provide Aerodrome Control Service, Alerting Service and Flight Information Services to aircraft, towing traffic and other vehicles moving inside the ground manoeuvring area. This means that at Schiphol Airport a ground controller is responsible for all movements happening in the ground manoeuvring area. [12, 1] The goals of a ground controller are to ensure safety, which means that separation needs to be kept between the different entities on the ground. Next, a controller needs to deliver the aircraft in the optimal sequence to the runway controller, which is needed to increase airport capacity. Lastly, the controllers need to maintain good streaming within the field meaning the moving aircraft are preferred above stationary aircraft, which increases the flexibility of the traffic and therefore the solution freedom the controller has. At Schiphol Airport the different ground controllers work in separate sectors. The maximum number of sectors in use is four, three of which form the main sectors that are controlled from the central tower. Of these main sectors, the North and South sectors, contain the bays of the Airport, meaning pushbacks and aircraft parking will happen in these two sectors. This generates a high traffic load as all traffic will have its origin or destination in one of these sectors. The remaining main sector, the Centre sector, has on average a

---

\*Msc Student, Sustainable Air Transport, Faculty of Aerospace Engineering, Delft University of Technology

significantly lower amount of traffic, creating a skewed task load distribution over the three sectors where the North and South sectors experience the majority of the task load. The Centre sector is therefore often merged with the North or South sector, creating a situation in which two controllers are controlling these three main sectors. These dynamics of merging and splitting the centre sector with the other sectors will be addressed in a case study to test the suggested methodology within this research. This is done by examining the change in task load within all main sectors that occurs when the centre sector is either split from or merged with the other sectors.

The measure suggested for estimating the ATCO task load is one based on dynamic density. The dynamic density methodology is data-driven and employs a set of measurable independent variables to estimate one dependent variable. Within this research, the to-be-estimated dependent variable is the ATCO task load, while the independent variables were selected and created via literature research and thorough operational analysis. For this methodology, the primary challenge lies in identifying and calculating measurable representative independent variables that exhibit a strong correlation with the ATCO task load. Once these independent variables have been created each parameter is assigned a certain weight which determines its contribution to the task load prediction.

Dynamic density has been used before in the ATM sector. Towards to end of the twentieth century, a collaboration was formed between NASA, the FAA and Metron Aviation with the purpose of researching the usage of dynamic density within Area Control. Each institution conducted independent research, resulting in three distinct metrics based on independent variables. These metrics were designed to estimate the ATCO task load of area controllers within the same airspace. Laudeman et al. [11], Sridhar et al. [21], and Wyndemere [23] formulated these metrics using a similar research framework that involved the selection and weighting of independent variables. Within these two phases, different approaches were taken by the different research groups. Within the variable selection phase, the focus of all researchers was primarily on traffic parameters, with Wyndemere [23] also considering pilot intentions. Different approaches were employed by the research groups in variable weighting. The methods used included unit-weighting, where all independent variables carried equal weight; subjective weighing, in which operational experts determined the weights based on their expertise and judgment; and regression analysis. Among these weight-selection methods, regression analysis demonstrated the most promising results, and will therefore be used throughout this research. The entire collaborative research has been combined in one metric by Kopardekar [10, 8], with this combined metric performing better than the three individual metrics. The general consensus was that dynamic density forms a useful measure for estimating task load for air traffic controllers. Other research performed by Manning and Pfeleiderer [16] and Masalonis et al [17] came to similar conclusions.

All the above-mentioned research focused on airborne traffic, mainly Area Control, not ground traffic, meaning there is a gap within the research of using dynamic density in ATM. This gap will be addressed within this research and from it, as well as from the need to be able to estimate ATCO task load within ground control, the following research objective was formulated. *To analyse the effect the splitting of the North-Centre sector has on the ground controller task load in Schiphol Tower Center.*

This research paper has the following structure. Firstly, the case study is explained in section 2, after which the methodology used within this research will be discussed, which happens in section 3. A thorough analysis of the results will take place in section 4. In section 5 the limitations of the research are discussed, after which the paper is finalised in section 6 with a conclusion.

## 2 Case Study

Within this study, a task load estimation model is introduced. This model will be used to analyse the utilization of splitting the Centre sector, which is done via a case study.

From within the central tower at Schiphol Airport three ground sectors are controlled, which are the North, South and Centre sectors. The number of controllers assigned to these sectors depends on the traffic volume. During nighttime operations, a single controller typically oversees all three sectors, whereas during the day, two or three controllers are assigned. In the case of two controllers, the Centre sector is merged with either the North or the South sector, whereas with three controllers, the Centre sector operates separately from the other sectors. The combined North-Centre sector refers to the sector in which the North and Centre sector are merged. The decision to work with two or three active controllers is dependent on the traffic load, the used runway configuration, and the active operational procedures. The procedure for using the Centre sector separately states that the Centre sector should be split when there is maintenance in the field or when de-icing is necessary. Simi-

larly, the Centre sector is split when two inbound and outbound runways are in use or when runway 18R/36L, which is the only runway located in the Centre Sector, is used as a landing runway, with the exception of the usage of landing configuration 18R + 18C. In other situations, the Centre sector will only be split off when the traffic load in the combined Centre sector gets too high. [13] This last reason will be the focus of this case study.

The majority of the time when the merged Centre sector is active, it will consist of a combination of the Centre and North sectors, instead of a combination of the Centre and South sectors. Through interviews conducted with ground control experts as well as a collaborative analysis of representative operational data, it was discovered that there are occasions when the Centre sector is not separated from the North sector despite the sector experiencing a high traffic load. The reason could be that the high traffic load was unexpected, or that the splitting of the Centre sector was not deemed necessary. The moments in which the Centre sector remained merged with the North sector despite a high traffic load are the focal points of this case study. Specifically, the task load of the North sector controller will be analysed for the situation in which the Centre sector stays merged with the North sector versus when it is split off. By comparing these scenarios, insights can be gained regarding the anticipated reduction in traffic load that the controller should experience when the Centre sector is assigned to a third controller.

The case study involved constructing a dataset using real-life ground radar data obtained from Schiphol Airport. This data was collected during instances where a single controller was responsible for the combined North-Centre sector while experiencing a high task load. The task load estimation was conducted for the entire dataset, considering both the merged and split situations. A comparison was then made between the task load estimates in these two scenarios and the differences were analysed. This analysis is needed to comply with the research objective in which the analysis of the splitting of the Centre sector was included.

### 3 Methodology

Dynamic density is a comprehensive metric that closely relates to ATC complexity. It can incorporate a wide range of factors and variables that can be classified into two categories: traffic density and traffic complexity. Traffic density is a quantitative measure of the number of aircraft within a specified volume of airspace, while traffic complexity parameters provide a measure of the level of air traffic complexity within that volume.[9, 11, 21] The parameters used in dynamic density are typically derived from traffic data, which enables the metric to be used for real-time decision support tools.[17] As the workload of ATCOs is largely determined by ATC complexity[18, 14], a methodology based on dynamic density can be employed to estimate the task load of ground controllers. This approach has been successfully applied in estimating the task load of ATCOs controlling the airborne segments of ATM in similar studies.

The dynamic density model will be created using a regression analysis that consists of the following stages:

- Data collection & processing
- Finding independent variables that could be used within the model.
- Performing a correlation analysis to check the correlation of the independent variables with the dependent variable, as well as the correlation between the different independent variables.
- Performing regression-based interactive model-building.

#### Data Collection & Processing

In the context of this research, the dependent variable is the task load experienced by ground controllers at Schiphol Airport. The regression analysis requires both a training dataset and a testing dataset, comprising both the independent variables and the corresponding dependent variable. Therefore, it is essential to have available datasets that contain information on both the independent variable (e.g., traffic data) and the dependent variable (e.g., task load measurements). The model used in this research will be created via a regression analysis. It will consist of different independent variables that, via a weighted summation, will quantify the dependent variable. The general formula used for the model is shown in Equation 1, in which the dependent variable is denoted as  $Y$ , the different independent variables as  $x_i$ , and the corresponding weights as  $W_i$ . In the context of this research, the dependent variable is the task load experienced by the ground controllers at Schiphol Airport. The regression analysis requires both a training dataset and a testing dataset, consisting of both the independent and dependent variables.

$$Y = \sum_{i=1}^n W_i \cdot x_i \quad (1)$$

Ideally, the dependent variable dataset would comprise of task load data obtained from the ground controllers during active operations. However, this data was neither available nor obtainable at Schiphol Airport during the research, meaning an alternative had to be found. Radio Telephony (RT) data is the alternative used. This data is related to the communication between the controllers and the aircraft on the ground. Most of the tasks that a controller will execute go hand-in-hand with a form of controller-pilot communication. It was observed in previous studies [15, 22, 19] that two RT parameters, namely the RT Occurrence and Total RT Time, had a proven and significant correlation with ATCO task load. The RT Occurrence represents the number of communication events that have taken place within a defined interval. A communication event can in this case either be controller-to-pilot or pilot-to-controller communication. The Total RT Time denotes the percentage of the defined interval in which the controller engages in active communication with the pilots. Both of these parameters were used in the correlation analysis, with Total RT Time demonstrating the best relationship with the independent variables. Consequently, Total RT Time was selected as the task load data to be utilized in this study.

The parameter of Total RT Time is a proven alternative to experienced task load measurements, and can therefore serve as the task load data needed to form the training and testing dataset. However, there are disadvantages in using this data type, when comparing it to task load measurements. Specifically, the Total RT Time parameter does not distinguish between communication events of varying task load intensities. Next to this, this parameter will not include the influence of non-RT-inducing task load events. Tasks that do not require RT will not be reflected in this parameter and, as a result, the regression model will only be representative of the task load that generates RT.

In this study, the selected data sources for the independent variable selection are Schiphol ground radar data and runway configuration data. The ground radar data provides the aircraft's coordinates over time, enabling the reconstruction of the traffic situation. With aircraft locations logged every second, various traffic parameters can be derived from this data source. The runway configuration data is the only secondary data source used, as this offers information about the specific runway configurations used at different times, and at which times the configuration changed. This data type is especially useful in the model analysis as the different runway configurations used have a large influence on the traffic flows within the ground sectors.

After the data source selection, the processing of this data is an important step, especially since the RT data and the ground radar data are collected in their rawest form. In the RT data, the starting time and duration of each call on the sector frequencies are registered and sorted per frequency. When two sectors are combined, and therefore controlled by one controller, one call will be repeated on both frequencies and therefore occur twice in the dataset. A combined sector can only be recognised by a consistent pattern of calls with equal starting time and duration over two sector frequencies. A margin of error of one second needed to be employed as the call on the repetition frequency can vary slightly in duration and starting time due to a small delay in the repetition. It is important that this process gives accurate results as from this data the sector configuration is determined, which plays a vital role in the case study as it heavily concerns combined sectors. From this processed data the Total RT Time can be calculated.

Similar to the processing of RT data, the ground radar data also requires processing. The dataset consists of recorded data lines for each active vehicle, with parameters such as recording time, location, speeds, and flight identification (ID) being the most important. While the focus of this research is on aircraft data, the dataset includes all types of vehicles present at the airport, including firefighters, ambulances, and other airport vehicles. Since not all vehicles can be identified by their flight IDs, a vehicle recognition tool was created. This involved calculating the origin and destination of each vehicle recorded in the data. If both locations were found to be within the airport boundaries, the vehicle was flagged as not being an outbound or inbound aircraft. Subsequently, all flagged vehicles were examined to determine if they deviated from the taxiways at any point. Vehicles that did not solely travel along the taxiways were filtered out of the data. This filtering step was necessary to retain only those vehicles that exclusively move on the taxiways, as these often include towed vehicles that can impact the traffic load experienced by the controllers.

## Independent Variables

Once the data collection phase is completed, the next step is to perform the independent variable selection. During this phase, a set of candidate independent variables is chosen, which will then undergo a correlation

analysis in the subsequent phase. The selection of candidate independent variables is guided by specific requirements: the variables must be calculable using the selected data sources, and there must be an assumed correlation between the candidate independent variable and the dependent variable. Since the reference data for the dependent variable is represented by the interval-based parameter of Total RT Time, the independent variables must also be interval-based.

In this study, the selection of independent variables was carried out through a combination of existing literature and expert judgment, with the latter being the primary contributor due to the limited availability of ground control-specific literature. To ensure a comprehensive selection process, two experienced former ground controllers from Schiphol Airport were consulted. An experiment was designed, where the experts were presented with various scenarios representing the most common traffic situations observed at Schiphol Airport. These scenarios encompassed approximately 75 hours of actual traffic data. The experts were then asked to analyze and identify the operational aspects that influenced the task load during these scenarios.

To facilitate the analysis and coordination of the experts' observations, a visual representation of the Airport Surface Detection Equipment (ASDE) Screen was created. The ASDE Screen is a radar display that provides real-time information on the movement of vehicles in the ground sectors, serving as a primary tool for ground controllers during operations. This visual representation enabled a clearer understanding of how aircraft were moving within the scenarios, facilitating interactive analysis. Additionally, a preliminary data analysis was presented to the experts, incorporating parameters such as the number of aircraft, pushback operations, and landings in each sector over time. This analysis provided a foundation for the experts to consider and contextualize their observations. Furthermore, a visual representation of the reference task load data was included to highlight moments in the scenarios when the reference data indicated a high controller task load. This reference data served as a guide for the experts' analysis, focusing their attention on specific time points of interest. Through this experimental process, a total of 11 potential independent variables were identified for further analysis. Each of these variables will be elaborated on in subsequent sections.

### **AC Count**

The aircraft count is the average number of aircraft that are located within a sector during the measured interval. This parameter appeared all across the consulted literature and was suggested by the ground control experts.

### **AC near Boundary**

This parameter was introduced in Chatterji (1997) [8] and has been adjusted to fit ground control operations. It represents the total number of aircraft within a given time interval that are in close proximity to a controlled sector and are moving towards it. This parameter is based on the concept of the area of regard, which refers to the area that an ATCO must monitor.[7] The ATCO not only monitors the aircraft within the sector but also those that are expected to enter the sector in the near future. As a result, the area of regard extends beyond the boundaries of the controller's sector. This monitoring is expected to increase the experienced task load of the controllers.

### **Handovers**

In air traffic management, a handover refers to the moment when an aircraft is transferred between sectors and, consequently, between ATCOs. Only handovers between ground controllers are considered in this parameter, while those between ground controllers and other ATCOs are excluded. This is because the communication between ground controllers and other ATCOs is not included in the task load data, which only encapsulates controller-pilot communication, and therefore does not contribute to the estimation of the task load when included in the model. The handovers are categorized into two different independent variables: the handovers-in, which refers to the aircraft transferred to the controller, and the handovers-out, which denotes the aircraft transferred to a different ATCO.

### **AC Distribution**

This parameter represents the level of distribution of aircraft over the sector. It is calculated by finding the average location over all aircraft coordinates and calculating the deviation every aircraft has from this average point. The average deviation all aircraft have forms the aircraft distribution parameter.

### **AC Direction**

This parameter called the direction variance, was discovered during discussions with the ground control experts and is the first ground control-specific variable identified. At Schiphol Airport, most of the taxiways in the three main sectors have a parallel counterpart. This parameter is included because it was found that ATCOs experience a higher level of task load when two different traffic flows need to move in the opposite direction over these parallel taxiways. Consequently, a lower task load is experienced when all traffic can move in one direction

over one of the parallel taxiways. The reason for this is that there is greater flexibility for problem-solving when one of the parallel taxiways is empty. Aircraft can be moved to the empty taxiway to leave the main traffic flow or re-enter it at a different location, aiding the ATCOs in their goals of streaming and sequencing. However, when two opposite traffic flows exist on the parallel taxiways, this problem-solving flexibility is severely limited, generating a higher task load.

### **Configuration Switch**

Based on the available data, an average of 15 runway configuration changes occur at Schiphol Airport on a daily basis. The traffic flows on the ground are significantly impacted during the period surrounding the configuration switch. In the few minutes leading up to the switch, some aircraft are already directed towards the new runways to maintain high runway capacity, while after the switch, some aircraft may still be moving according to the previous configuration flows, having just landed before the switch. As a result, there are several traffic flows moving simultaneously, leading to an increased task load for the ATCOs. To capture this effect, a boolean parameter indicating whether a runway configuration change occurred during the interval is proposed.

### **Pushbacks**

The pushback count as a parameter is the number of pushbacks that have occurred within the controlled sector during the interval. When an aircraft has its pushback, the controller will need to communicate the further steps to be taken by this aircraft, which means the controller needs to create and communicate the aircraft route to the runway with the pilot. This is expected to generate a significant task load.

### **Landings**

The landing count is a parameter that captures the number of landings that have occurred within the controlled sector during the interval. When an aircraft has landed, a controller will, similar to with the pushbacks, have to create and communicate the route to the gate with the pilot, generating a task load. Next to this, the aircraft will need to be merged into the existing traffic streams directly after landing.

### **Bay Traffic**

The bay traffic parameter was first mentioned when discussing the potential independent parameters with the ground control experts. The suggested parameter consists of a summation of the number of bays in the sector that are occupied by at least two active aircraft. This parameter is included as the experts indicated that a high number of aircraft within one bay is not only task load intensive at the moment of controlling these aircraft, but it can also disrupt the planned sequence, creating a higher task load in the following minutes.

### **Stationary Aircraft**

The stationary aircraft parameter encapsulates the effect undesired stationary aircraft on a taxiway have on the ATCO task load. When an aircraft comes to a halt on a taxiway, it can obstruct the flow of other traffic in the area, forcing the ATCO to re-evaluate the routes of all aircraft, and potentially issue alternative routes. This can have a severe impact on the task load of the controller.

## **Correlation Analysis**

Once the candidate independent variables are identified, a correlation analysis is conducted to establish their relationship with the dependent variable. This step is necessary because the regression analysis will incorporate every feature that has the potential to reduce the overall model error on the training data, regardless of whether or not this feature is related to the dependent variable. All candidate features not correlating with the dependent variable data will be dropped, and a second correlation analysis will be performed between the remaining features themselves. This second analysis is needed to prevent multicollinearity, which occurs when multiple features included in a regression model are correlated to each other and therefore contribute the same information to the dependent variable estimation.[4] Multicollinearity will make it difficult to examine the influence of the different features within the model and should therefore be avoided.

The correlation analysis method used within this research is the Spearman Rank-Order Correlation, which together with the Pearson Product-Moment Correlation form the two most widely used correlation techniques. [3] The Spearman coefficient is based on the rank of the parameter data points whereas the Pearson coefficient is based on the value of these data points. This makes the Spearman coefficient less sensitive to outliers in the data. The requirements for the Spearman correlation are that the dataset needs to be able to be ranked and that the to be correlated variables should have a monotonic relation. A monotonic relation means that the variables move in a similar general direction, meaning that an increase in variable A should always generate a similar movement in variable B. Examples of monotonic relations are linear and exponential relations, while an

example of a non-monotonic relation is a sine function.

The Spearman coefficient can be calculated via Equation 2, in which the calculated coefficient, the number of data points and the indexes of the ranked data points are denoted by  $r_s$ ,  $N$ ,  $x_{i,r}$  and  $y_{i,r}$  respectively.

$$r_s = 1 - \frac{6 \sum_{i=1}^N (x_{i,r} - y_{i,r})^2}{N(N^2 - 1)} \quad (2)$$

Within this research, the Spearman correlation was chosen due to its ability to be used on datasets that include outliers, as both the reference task load data, as well as the data points of the independent variables contain a significant number of outliers.

## Model Building

The final phase of the model creation process is the model building phase. In this phase, the candidate independent variables that have passed the correlation analysis are used to construct the model. The model building phase involves conducting a multiple least-squares regression analysis. The main objective of the regression analysis is to determine the relationship between the selected independent variables and the dependent variable with the highest possible predictive accuracy. The regression analysis aims to identify the optimal combination of independent variables and their corresponding weights that best quantify the dependent variable.

The type of multiple regression used in this research is stepwise estimation, which is a sequential search approach. This stepwise estimation method starts with an empty model to which one initial independent variable is added. This is the variable that has the highest statistically significant individual contribution to the prediction of the dependent variable. This individual contribution is represented by a t-test P-value and a significance level ( $\alpha$ ) of 0.05, the feature with the smallest P-value has the largest individual contribution, with this P-value needing to be at least the significance level.

To this initial model, additional variables will be added, while existing variables may be removed. Whether or not a variable can enter or stay in the model depends on its contribution to the predictive power of the model. The contribution of a feature to the dependent variable prediction can change with the inclusion of different features as the features in a model can interfere with each other. When an independent variable is no longer significantly contributing to the prediction it is dropped from the model. This process continues until no independent variables can be added to increase the overall predictive power of the model in a statistically significant way. The algorithm used for this stepwise estimation is shown in Algorithm 1, in which the entered features are represented by  $X$  and the features outside the model are represented by  $Y$ . The t-test P-value for feature  $x$  is denoted as  $P(x)$ .

---

### Algorithm 1 Stepwise estimation algorithm

---

```

1:  $X \leftarrow x$  {Inside model features}
2:  $Y \leftarrow y$  {Outside model features}
3: Initialisation: Add  $x$  with the smallest P-value below  $\alpha$ .
4: while  $Y$  not empty do
5:    $F_y$  equals Y-feature with lowest  $P(y)$ 
6:   if  $F_y < \alpha$  then
7:     Add  $F_y$  to  $X$ 
8:     Delete  $F_y$  from  $Y$ 
9:   else
10:    break
11:  end if
12:   $F_x$  equals X-feature with highest  $P(x)$ 
13:  if  $F_x > \alpha$  then
14:    Add  $F_x$  to  $Y$ 
15:    Delete  $F_x$  from  $X$ 
16:  end if
17: end while=0

```

---

The output of the stepwise estimation should be the model with the highest predictive power, while only incorporating features that have a statistically significant contribution in the prediction. A training and testing

dataset will be established to be used within the model-building process. For stepwise estimation, the ratio between training data points and the number of independent variables should be 50:1, which is needed to lower the tendency to become sample-specific and increase generalizability. [5, p 279] The testing dataset will be half the size of the training dataset.

The model will be evaluated using the coefficient of determination, which is the percentage of the prediction variance that is explained in the model. Next to this, the Spearman correlation coefficient will be used to evaluate the correlation between the ranked reference data and the ranked estimations. This will provide insight into how well the estimation follows the same order as the reference data.

### **Verification & Validation**

In a regression analysis, the verification and validation (V&V) process is crucial to assess the performance and reliability of the model. While some aspects of V&V are automatically addressed during the analysis, the predictions are constantly compared to the actual values bringing forward discrepancies and deficiencies in the model, there are additional tests that should be conducted to ensure the accuracy and robustness of the model.

One important aspect to analyze is the homoscedasticity of the residuals. Homoscedasticity refers to the equal variances of the residuals across all predictions. If the residuals exhibit homoscedasticity, it indicates that the independent variables have consistent prediction power throughout the range of the dependent variable. On the other hand, if there is heteroscedasticity, with varying variances of the residuals, it suggests potential bias or unevenness in the model. Such discrepancies in variance can skew the prediction results. Therefore, assessing homoscedasticity helps identify any potential deficiencies in the model.

Another test that can be conducted is evaluating the normality of the residuals. Normally distributed residuals indicate that there are no significant unexplained relationships or trends in the dataset. Deviations from normal distribution suggest the presence of remaining patterns or biases that the model has not captured. Therefore, checking for normality in the residuals provides additional insights into the adequacy of the model.

The model is initially built using a training dataset, where the weights are fitted to the data. Subsequently, the model is tested using a separate testing dataset to determine its coefficient of determination. To ensure the reliability of the model, it is important to use multiple testing datasets and evaluate the consistency of the predictive power across these sets. If there are significant differences in the results obtained with different testing datasets, it suggests that the model may be biased towards specific types of data. This could limit its generalizability and reliability.

## **4 Results**

The methodology outlined above was implemented in the context of ground control operations at Schiphol Airport, with the different sectors being analysed individually. Specifically, the North, South, and Centre sectors, as well as the North-Centre and South-Centre combinations, were examined. Each sector underwent separate correlation analysis and model-building processes. This approach was necessitated by the inherent variations in characteristics and layout among the sectors, leading to substantial differences in traffic flows. By modelling each sector independently, the potential predictive power of the models for each sector was enhanced. Subsequent sections will delve into the details of the resulting models and their subsequent implementation in the case study. This comprehensive approach enables a thorough examination of the ground control environment at Schiphol Airport, taking into account the unique characteristics and operational dynamics of each sector.

### **Estimation Model Results**

For each of the five sector combinations, a thorough analysis was conducted to examine the correlation between the candidate independent variables and the task load, as well as the intercorrelation among the candidate features themselves. All candidate features that showed a correlation with the dependent variable, and no intercorrelation among themselves, were included in the subsequent stepwise model-building process. The outcomes of this process for all sectors are presented in Table 1. In the table, the weights assigned to the features are displayed, with some weights being zero, indicating that the corresponding candidate features passed the correlation analysis but were not selected during the model-building process. Absence of a weight or the absence of a candidate feature in the table indicates that the feature did not meet the correlation criteria for the specific sector. The sectors are denoted by their first letter, and the runway configuration switch feature is labelled as "RWC Switch" in the table.

Table 1: Model parameters

Feature	N	S	C	NC	SC
<b>Intercept</b>	0.063	0.030	0.131	-0.012	0.168
<b>AC Count</b>	0.065	0.091	0.039	0.058	0.035
<b>Handovers</b>	0.011				0
<b>AC Direction</b>		0	0		0.002
<b>Pushbacks</b>	0.018	0.021		0.017	0.031
<b>Landings</b>	0	0	0.007	0.006	0.010
<b>Bay Traffic</b>	0.013	0.023		0.026	
<b>RWC Switch</b>	0.036	0	0	0	0

The analysis yielded distinct models for each sector, with significant variations in the number of independent variables included. The models ranged from two to five independent variables, and each model had a unique combination of features. The aircraft count was the only feature consistently present in all models across sectors. It exhibited the highest unique contribution, indicating that its removal would have the greatest impact on the predictive power of the models. Specifically, in the testing set, the aircraft count accounted for 67% to 98% of the prediction power for different sector models individually. Since several other features provided similar information, dropping the aircraft count from the full models resulted in a decrease in prediction power ranging from 22% to 57%.

These findings underscore the crucial role of the aircraft count as a key determinant in estimating task load across different sectors. However, it is important to note that the other features also contribute significantly to the predictive power, highlighting the multifaceted nature of the task load in ground control operations at Schiphol Airport.

When applying these different dynamic density models to the test datasets established, the coefficient of determination and the Spearman correlation coefficient for each model can be calculated. The calculated coefficients, grouped per sector, are shown in Figure 1.

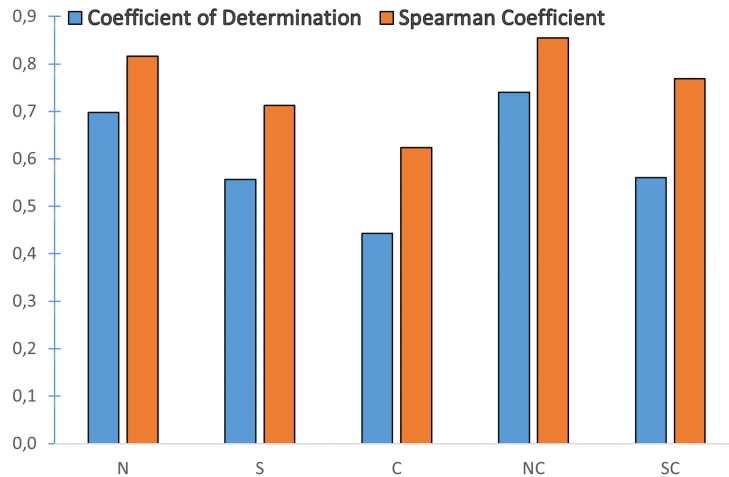

Figure 1: Coefficient of determination and Spearman coefficient

It can be seen that there are significant differences between the prediction accuracy of the different sectors. The North and combined North-Centre sector are the only sectors with a coefficient of determination above 0.7, which is considered a good level of prediction power. The other three sectors, and especially the Centre sector, show a significantly weaker prediction power. The Spearman coefficient shows a strong correlation for all sectors, with the North and combined North-Centre sectors as the standouts. The Spearman coefficient determines the ranked correlation, meaning it determines if the highest and lowest points of the reference and estimation data are located at the same places within the dataset. The coefficient shows how well the normalised shape of the two graphs matches. In the case of these models the Spearman coefficients show a strong correlation, meaning the missing prediction power is caused by the magnitude of the estimations, as the estimations show a similar increasing and decreasing pattern as the reference data. There are several reasons for these results to differ per sector, all of which have been discussed with and agreed on by ground control experts. These reasons are elaborated on within this section.

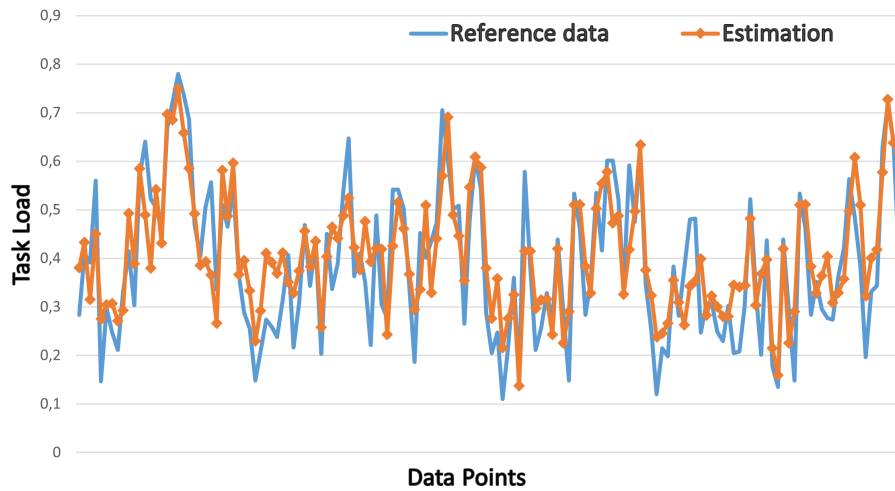

Figure 2: North Sector: Estimation vs Reference

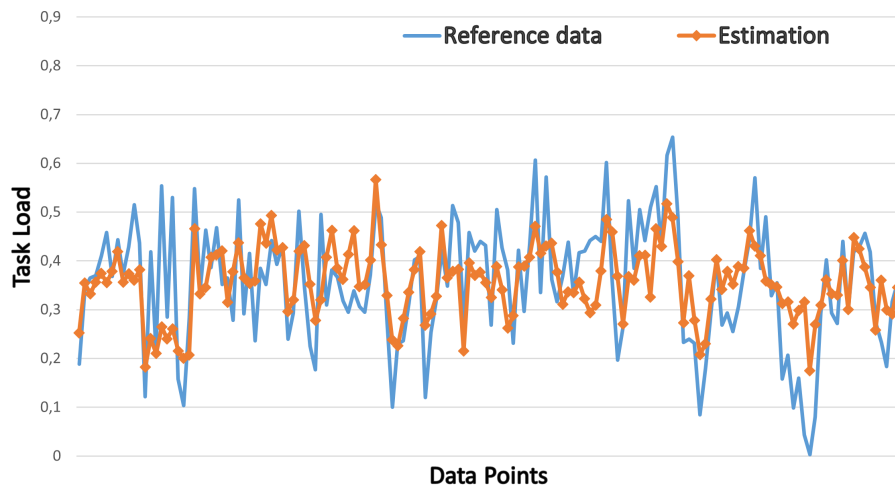

Figure 3: Centre Sector: Estimation vs Reference

### Low task load prediction

One limitation of the sector prediction models is their ability to accurately predict low task load moments. This can be observed in Figure 2 and Figure 3, which depict the estimations made by the models for the test datasets of the North and Centre sectors, respectively. It is evident that the estimation models perform better at higher levels of task load compared to lower levels. This discrepancy can be attributed to the standardized nature of controller-pilot commands.

During periods of high task load, controllers need to communicate efficiently, employing concise and standardized commands. However, during periods of low task load, controllers may include additional information in their commands, leading to longer RT calls. For instance, they may greet the pilot with a "Good morning" or modify commands such as "go via Echo 5" to "you may take Echo 5," resulting in increased command duration. The challenge for the estimation model lies in the fact that these less efficient commands are not consistently used during low task load periods. The usage of such commands varies among controllers, as some may still prioritize efficiency even when experiencing low task load.

The duration of commands directly impacts the Total RT Time, which represents the percentage of time within an interval that the RT is actively used by pilots or controllers. Consequently, the reference data is influenced by the communication style employed during low task load periods. This introduces a situation where the reference data becomes dependent on whether a controller needed to communicate as efficiently as possible. It is important to note that these discrepancies in messaging efficiency do not affect the responsibilities and quality of work delivered by controllers. However, they do reduce the predictive power of the models during low task

load periods compared to a scenario where messaging is entirely standardized.

Nevertheless, it is important to emphasize that these models primarily focus on examining high task load periods, meaning a lower prediction power during low task load periods will not heavily influence the research. This phenomenon affects all sector estimation models, and it is crucial to consider its impact when interpreting the model's estimations.

### **Centre sector prediction**

The Centre sector exhibits a significantly lower coefficient of determination, indicating a lower prediction power compared to the other sectors. Figure 3 shows the estimations made by the Centre sector model for the testing dataset, revealing instances where the estimations deviate considerably from the reference data. To comprehend this discrepancy, it is necessary to understand the unique characteristics of the Centre sector.

Firstly, the layout of the Centre sector sets it apart from the other sectors. Unlike the other sectors, the Centre sector does not encompass any crucial bays where pushbacks can occur. Consequently, two candidate independent variables related to the bays are not applicable in this sector. In the Centre sector model, only two features are included: aircraft count and the number of landings.

Secondly, the Centre sector has two distinct operational scenarios. It serves as an active sector when the centre runway is utilized for landings, or as a means to reduce the task load of the controller overseeing the combined sector, as discussed in section 2. However, both scenarios are currently encompassed by a single estimation model, even though the influence of the features on the dependent variable differs significantly between the two situations. When the Centre sector is active to alleviate the high task load of the North or South controller, the number of landings occurring in the Centre sector is often zero as the Centre runway is not in use, meaning only the aircraft count remains as a feature.

The low prediction power for the Centre sector stems from the contribution of the aircraft count to the prediction. In all sectors, the aircraft count serves as an important independent variable, accounting for at least 70% of the predictive power of the dependent variable on its own, with the remaining predictive power derived from the inclusion of other features. However, in the Centre sector, the aircraft count exhibits significantly lower prediction power compared to the other sectors. Two key reasons contribute to this lower predictive power of the aircraft count parameter.

Firstly, the Centre sector experiences a notably lower average task load. Analysis of the available reference data reveals that only 1% of the intervals in the Centre sector have a Total RT Time above 0.6, compared to approximately 18% for the other sectors. As previously discussed, the overall predictive power of the models diminishes when the task load is low.

Secondly, communication within the Centre sector is less frequent and regular. In contrast to the other sectors where pushbacks and landings generate significant communication, the Centre sector has no pushback activity. The regular communication related to this activity is easier to predict than communication related to conflict and flow management, leading to an overall lower prediction power.

### **South sector prediction**

The South sector has a significantly lower coefficient of determination than the North sector, for which the reason was analysed. When analysing the error distribution of the estimation in the South sector test data, it was clear that one specific period of time was poorly estimated, lowering the overall model prediction power. During the analysis, it was found that a D-pier transfer had taken place during this time period. A D-pier transfer is the event in which the D-pier, which is normally part of the North sector, will become part of the South sector for a limited period of time. This is one of the used methods to distribute the task load more evenly over the North and South sector during periods in which the North sector has a high task load. Unfortunately, the moments at which a D-pier transfer occurs are not logged, meaning it cannot be incorporated into the model, which is discussed to a greater extent in the Discussion section of this article. Around 10% of the test dataset is influenced by this D-pier transfer, when this portion of the data is replaced by data that has an average error similar to the remaining 90% of the dataset the coefficient of determination increases to 0.7, equaling the prediction power of the North sector. This shows that the prediction power of the South sector is good, but that the test dataset contained an abnormality.

### **South-Centre sector prediction**

A very similar situation occurred for the South-Centre sector, in which again a 10% portion of the test dataset was badly predicted. After analysis, it was found that this portion of the data was recorded while the runway

configuration was a combination of starting on runway 06 and 18R while landing on 09. This is a configuration that occurs at Schiphol Airport less than 0.5% of the time, and that was not included in the training dataset. During the use of this particular configuration, there are three different traffic flows of which two consist of inbound traffic and one consists of outbound traffic. All these traffic flows converge in the South sector leading to an unusually large amount of communication related to conflict resolution. Since the model is based on historical data from the most common runway configurations, in which a lower level of conflict resolution occurs, it will underestimate the contribution of this conflict resolution to the communication in this rare configuration. This leads to a too-low task load estimate and therefore a lower overall prediction power. Since this runway configuration is very rare, it can be seen as an anomaly. When replacing this portion of the test dataset with a portion that has an average error equal to the average error of the remaining test dataset, the coefficient of determination increases to 0.65, which is closer to the other well-performing sectors.

It can be stated that of the five estimation models, the models for the North and North-Centre sectors perform very well. The South and South-Centre sectors performed significantly worse, however, the reasons for this poor performance are clear, and when mitigating these reasons the two sectors perform significantly better. The only model that performed poorly is the Centre sector, which showed to be a sector unfit for the used methodology.

## Case Study Results

The case study focuses on analysing the impact of splitting the combined North-Centre sector on the task load of the North sector controller. The objective is to determine whether this splitting reduces the task load for the North sector controller and identify the factors that influence the extent of this reduction. To achieve this, a dataset consisting of historical data is analysed, where the combined North-Centre sector was controlled by a single controller experiencing a high task load. These moments were chosen as splitting of the North-Centre sector is an often used mitigation against the high task load of the North sector controller. The results of this case study can show whether this is an effective mitigation.

The estimation models developed within this research for the North sector and the combined North-Centre sector are utilised to estimate the task load generated in these two sectors across the entire dataset. This estimation is based on the actual historical traffic flows. As a result, two task load estimations are obtained: one for the combined North-Centre sector and another for the North sector without the Centre sector. By comparing these estimations, the impact of splitting the Centre sector from the combined North-Centre sector on the controller's task load can be assessed.

Figure 4 presents the estimations of the task load in both sectors within the case study dataset. These estimations serve as a basis for analyzing the estimated influence of the Centre sector's splitting on the controller's task load.

As can be seen in the Figure 4, the influence of splitting the combined North-Centre sector varies across the dataset. To provide context, Figure 6 and Figure 5 display the number of landings and the aircraft count corresponding to the estimation data points in the Centre sector. As expected, the influence of splitting the North-Centre sector has the largest effect when there is a high level of activity within this sector. Conversely, when the activity level is lower, the impact becomes negligible, as can be seen by the unmitigated graphs in Figure 4. During these instances, the task load is primarily generated by the traffic load present in the North sector, which remains unaffected by the split from the Centre sector.

However, there are periods within the dataset where the split's influence is highly significant. These periods coincide with the utilization of the Centre runway for landings, resulting in a potential task load reduction of up to 58% compared to the original value. This significant impact can be attributed to the fact that landings, along with pushbacks and the merging of this incoming traffic, represent communication-intensive moments within the ground control process. At this stage, the controller must communicate the route to the gate with the pilot, leading to a substantial amount of RT communication.

Based on the findings of this case study, it can be concluded that splitting the Centre sector from the combined North-Centre sector can significantly reduce the task load for the North sector controller. However, this reduction in task load is observed primarily when there is a substantial amount of activity in the Centre sector, particularly when the Centre runway is utilized for landings. In situations where the Centre runway is not in use, the impact of the split on the North sector controller's task load is found to be negligible within the used data set. Therefore, it can be inferred that employing the splitting of the Centre sector as a mitigation strategy for alleviating the high task load experienced by the North sector controller is effective, but only when the specific circumstances of having a significant amount of active traffic in the Centre sector are met.

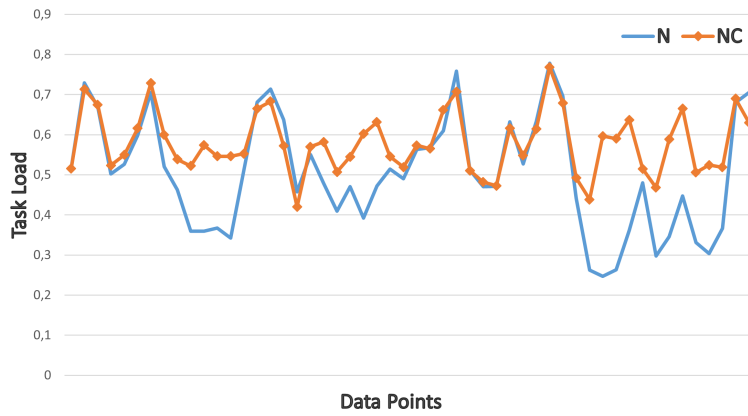

Figure 4: Case Study: Task load comparison N & NC sector

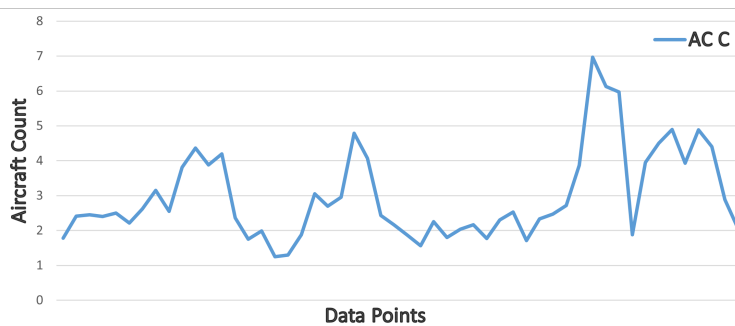

Figure 5: Case Study: Number of Aircraft in Centre sector

## 5 Discussion

The objective of this study was to introduce a methodology based on the Dynamic Density principle for estimating the task load of ground controllers at Schiphol Airport and to evaluate this by a data and results analysis. The proposed methodology was effective in four of the five ground control sector combinations examined in this study. However, it is important to acknowledge and address several limitations of the study, which are outlined in this section. Additionally, notable model decisions that have a significant impact are discussed for further analysis and understanding.

It is important to acknowledge that the candidate independent variable selection phase of the research is the most complex and influential phase of the research. Most of the limitations mentioned in this research are allocated within this phase, as these limitations create the largest constraint on this feature selection and therefore the results of the model.

### Reference data

As mentioned before, the ideal type of reference data, namely measured experienced controller task load data, was not available for this research. This led to the usage of RT data as reference data within this study, which gives a good estimation of the controller task load. However, it is important to acknowledge the significant limitations associated with this approach.

Firstly, this type of data directly links RT data with task load and does not distinguish between the varying task load intensities that different communication events can have. This limitation prevents a finer-grained analysis of task load variations. Secondly, non-RT-inducing task load events are not captured in the reference data, resulting in the exclusion of these events from the model. For example, during the correlation analysis within this study, the candidate independent variable of the number of aircraft near the boundary was considered. This parameter includes aircraft that have not yet entered the controlled sector but are approaching it. Several ground control experts suggested that monitoring these aircraft imposes task load. However, no significant correlation was found between this parameter and the reference data, which is expected since monitoring aircraft outside the controlled sector does not generate RT within the sector. Consequently, this candidate independent variable

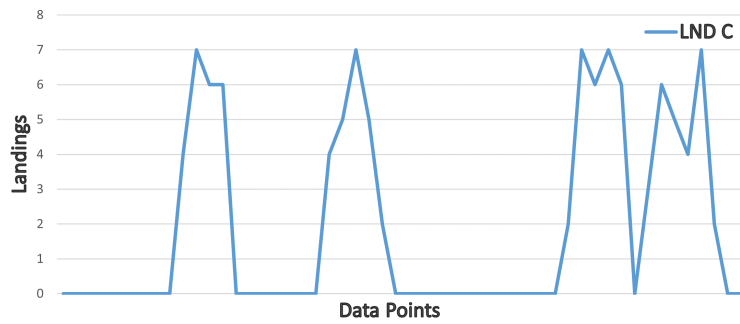

challenges during the dynamic density model building process, as the model may struggle to accurately capture and predict the effects of these unique traffic patterns. This irregularity was encountered in the testing dataset for the South-Centre sector during the analysis.

The last irregularity arises from infrequent events such as a malfunctioning aircraft on the taxiway, taxiway maintenance, or heavy snowfall. Although the occurrence of such events is not explicitly included in the data, they can have a significant impact on traffic flows in unconventional ways. These events can decrease the overall predictive power of the model during those specific moments, as the model may not account for the unusual traffic patterns resulting from these events.

## Model decisions

Within the model setup of this study, two significant decisions were made that influenced the structure of the model.

The first decision was to not differentiate between different runway configurations within the model but instead use them for analytical purposes only. The model was designed to be sector-specific, regardless of the specific runway configuration used. This decision aimed to increase the versatility of the model but resulted in a potentially lower overall predictive power. By not training the model specifically on each runway configuration's traffic flows, the model may not capture the nuances and intricacies of individual configurations. However, considering the large number of different runway configurations used at Schiphol Airport, making the estimation models configuration-specific would have been challenging to implement. Therefore, the decision was made to sacrifice some predictive power for the sake of practicality and generalizability.

The second decision made was to design the model as interval-based, aligning with the interval-based nature of the reference data used. This decision made analysing the time delay between task load-inducing events and the actual generation of task load difficult. In reality, there may be a time delay between events like pushbacks and the subsequent task load generated by these events. However, due to limitations in the available data, it was not possible to estimate the potential time delay of different task load-inducing events. In this research, the consequence of potential time delays was limited as the calculations were performed within intervals that were significantly larger than any potential delay. However, if an event occurs at the very end of an interval, the task load generated by that event may in reality be attributed to the next interval, which will not match the model, reducing the predictive power of the model in both intervals.

## 6 Conclusion

In summary, the goal of this study was to propose a methodology based on the concept of Dynamic Density, with which the task load of ground controllers at Schiphol Airport could be estimated while illustrating the application of this methodology using a case study based on the splitting of the combined North-Centre sector. This led to the following research objective: *To analyse the effect the splitting of the Centre sector has on the experienced ground controller task load in Schiphol Tower Center.* This objective has been largely successfully achieved and the analysis was performed.

Estimation models based on the Dynamic Density principle were successfully established for four out of the five ground control sector combinations at Schiphol Airport. These models demonstrated good predictive power, with two of them achieving coefficients of determination of 0.7 and above. The remaining two models also reached this level of predictive power when the test dataset was adjusted to remove abnormalities. However, the model created for the Centre sector showed poor predictive power compared to the other sectors. It was determined that the main reason for this discrepancy is the significant variation in the Centre sector and its traffic flows, which differ too much from the other sectors to be effectively modelled using the same approach.

The models developed for the North and combined North-Centre sectors were utilized in the case study to analyze the reduction in task load for the North sector controller when transitioning from the combined North-Centre sector to the North sector. The objective was to determine if and when splitting the combined sector could effectively mitigate the high task load experienced in the North-Centre sector. The analysis revealed that the mitigation was primarily effective when the Centre runway was utilized for landings. In such cases, splitting the combined sector led to a significant decrease in the task load experienced by the North sector controller. However, when the Centre runway was not used for landings, the splitting of the combined sector had no notable impact on the task load of the North sector controller. Therefore, it can be concluded that splitting the combined North-Centre sector can serve as an effective mitigation strategy for the high task load

experienced by the North sector controller, but only when implemented during the appropriate circumstances of having a significant amount of active traffic within the Centre sector.

This research has shown that the dynamic density measure can be used to estimate controller task load within ground control at Schiphol Airport. As data-driven estimation methods are not yet commonly used at Schiphol Airport, this research forms a first step in that direction. Since only traffic parameters were used, it also forms the beginning of a real-time decision-support tool in which live or predicted traffic parameters can be used within the model to estimate the future task load. The research uses a clear and general setup, making it an example of how to use dynamic density within a technical field, as well as showing how to find the complexity within a technical field in which no prior research has been performed. For future research in the field of applying the concept of dynamic density to estimate task load in Air Traffic Ground Control, there are two main intriguing directions to explore.

Firstly, it would be valuable to use this study as a proof of concept and replicate the steps while incorporating the most representative available reference data types. Particularly, utilizing measured experienced controller task load data as reference data instead of relying on RT data could enhance the models' predictive power. By using measured task load data directly, the estimations would align more closely with the parameter of interest, which is the actual experienced task load. This shift in reference data would allow for a broader range of potential independent variables, as all controller activities would be encapsulated in the reference data. This means that the independent variables would not be limited to traffic-based parameters alone, but could also include factors influenced by coordination with other controllers, for example. Expanding the scope of independent variables could lead to more comprehensive and valuable models.

The second area of interest for future research is investigating the influences of the runway configuration system at Schiphol Airport. Given the significant number of different runway configurations employed at the airport, numerous distinct traffic flow scenarios arise, each impacting the work of ground controllers in diverse ways. Focusing research efforts on this aspect could yield models with higher predictive power and provide new insights into the effects of various configurations on ground controller operations. Exploring the relationship between runway configurations and task load could contribute to improved understanding and optimization of ground control processes.

By pursuing these research directions, advancements can be made in refining the models, enhancing their predictive capabilities, and gaining deeper insights into the complexities of task load estimation in Air Traffic Ground Control.

## References

- [1] N. Ashford et al. *Airport Operations*, volume 3. McGrawHill, New York, 2013.
- [2] K. Brookhuis et al. Driving with a congestion assistant, mental workload and acceptance. *Applied Ergonomics*, pages 1019–1025, 2009.
- [3] J. de Winter and S. Gosling. Comparing the pearson and spearman correlation coefficients across distributions and sample sizes: A tutorial using simulations and empirical data. *Psychological Methods*, 21(3):273–290, 2016.
- [4] L. Eberly. *Topics in Biostatistics- Multiple Linear Regression*. Humana Press Inc, Totowa, New Jersey, USA, 2007.
- [5] J. Hair et al. *Multivariate Data Analysis*. Cengage Learning, EMEA, Andover, United Kingdom, 8 edition, 2019.
- [6] S. Hart and L. Staveland. Development of the nasa-tlx (task load index), results of empirical and theoretical research. *Human Mental Workload*, pages 139–183, 1988.
- [7] J. Histon. Introducing structural considerations into complexity metrics. *ATC Quarterly*, 10, 5 1995.
- [8] P. Kopardekar. Dynamic density: A review of proposed variables. *Federal Aviation Administration William J. Hughes Technical Center*, 2000.
- [9] P. Kopardekar. Dynamic density: Measuring and predicting sector complexity. *Proceedings of the 21st Digital Aviation Systems Conference*, pages 63–102, 2002.

- [10] P. Kopardekar and S. Magyarits. Measurement and prediction of dynamic density. *FAA Report No. dd\_atm2003\_7-03*, 2003.
- [11] I. Laudeman et al. Dynamic density: An air traffic management metric. *Report No. NASA/TM-1998-112226*, 1998.
- [12] LVNL. Werkboek ut spl gnd. Internal Document.
- [13] LVNL. *Internal Procedural Document LVNL (LVNL OPS Manual Ground)*. Air Traffic Control the Netherlands (LVNL), Schiphol, The Netherlands, 2023.
- [14] A. Majumdar et al. En-route sector capacity estimation methodologies: An international survey. *Journal of Air Transport Management*, 11(06):375–387, 2005.
- [15] C. Manning et al. Using air traffic control taskload measures and communication events to predict subjective workload. Technical Report FAA, 06 2002.
- [16] C. Manning and E. Pfeleiderer. *Relationship of Sector Activity and Sector Complexity to Air Traffic Controller task load*. Number Report No. DOT/FAA/AM-06/29. FAA Civil Aerospace Medical Institute, Oklahoma City, Oklahoma, USA, 2006.
- [17] A. Masalonis et al. Dynamic density and complexity metrics for realtime traffic flow management. *Proceedings of the 5th USA/Europe Air Traffic Management RD Seminar, Budapest, Hungary*, 2003.
- [18] R. Mogford and P. Kopardekar. The complexity construct in air traffic control: A review and synthesis of the literature. *Report No. FAA/CT-TN95/22*, 7 1995.
- [19] D. Potterfield. Evaluating controller communication time as a measure of workload. *The International Journal of Aviation Psychology*, 7(2):171–182, 1997.
- [20] W. Rouse et al. Modelling the dynamics of mental workload and human performance in complex systems. *IEEE Transactions on systems, cybernetics*, 23:1662–1671, 1993.
- [21] B. Sridhar et al. Airspace complexity and its application in air traffic management. *Proceedings of the 2nd USA/Europe Air Traffic Management RD Seminar, Orlando, USA*, 1998.
- [22] N. Uclés and J. García. Relation between workload and duration of atc voice communications. *6th International Conference on Research in Air Transportation (Istanbul)*, 06 2014.
- [23] Wyndemere. *An Evaluation of Air Traffic Control Complexity*. Number Final Report Contract NAS2-14284. Wyndemere, Boulder, Colorado, USA, 1996.



# II

Literature Study  
previously graded under AE4020



## Introduction

The task load of air traffic controllers is often seen as a restricting factor on the capacity of either the airspace or the airport. This has been widely researched for the airborne portions within air traffic control, such as Area Control and Approach Control. This is mostly due to the fact that most air traffic controllers work within these departments, as well as that these portions of air traffic control are very similar around the world. Quite opposite to this lays the department of Ground Control. These are the controllers that control all traffic that is moving from the gates to the runways, or vice versa. Since every airport has a very different ground infrastructure, research about what generates task load will often be very airport specific. Next to this lays the fact that the task load within ground control is not as often seen as a capacity restriction as it does in for example area control. However, at Schiphol Airport the high levels of task load for ground control are seen as one of the main influences on the complexity of overall traffic handling. This complexity is related to the capacity of Schiphol Airport, and therefore creates a relation between the ground control task load and the traffic capacity at Schiphol Airport.

When a certain parameter, like task load, is related to important aspects of an airport, it is important to have a way to measure or estimate this parameter. This is needed to be able to see if certain adjustments made change the situation in a positive or negative way. Otherwise mitigating the problem becomes troublesome. Preferably it would even be possible to estimate the effect a certain mitigation will have before it is implemented. Therefore, this research aims to create a way of estimating the task load experienced by ground control using only the to-be-controlled traffic situation. When the traffic situation is the only input it becomes possible to estimate how certain mitigations will influence the experienced task load. To accomplish this a dynamic density model will be created. This is a model in which different measurable traffic parameters are added together. All these parameters are multiplied by a certain weight, and when summed it forms the estimation for the task load. This model will then be tested on estimating the effect of one specific mitigation of the high task load on Schiphol Airport.

The aim of this report is to generate a literature review that will provide the reader with a better understanding of the current practices within the research area, as well as of the methodology used within this research. From this, a report with the following structure was created. In chapter 2 an overview of Schiphol Airport is given, while primarily focusing on the aspects that are of interest to this research. These are mainly the layout of Schiphol Airport as well as the used runway configurations. After this, chapter 2 will continue this tread by focusing on Schiphol Airport purely from ground control. This means exploring the responsibilities of a ground controller as well as the place it has within the larger airport structure. These two chapters form the physical field in which the research takes place. Next, chapter 4 discusses the parameter that is of interest to this research, namely the task load and how it is connected and correlated to the ground controllers. From here chapter 5 and chapter 6 discuss the methodology used to research the parameter of task load within the research field of ground control at Schiphol Airport. This methodology consists of the earlier mentioned dynamic density model, as well as the correlation and regression methods needed to create this model. This report ends with chapter 7 and chapter 8, in which the overall research plan is provided, as well as the conclusion to this report.



## Schiphol Airport Operations

Schiphol Airport is an important part of this research, as it is the physical place in which the research takes place. The general layout is important as the runways and taxiway infrastructure determine how the traffic flows over the airport. Next to this, the used runway configuration is discussed in this chapter, as these also influence the traffic flows.

### 2.1. Schiphol Airport

Schiphol airport is located in the Netherlands just west of Amsterdam. It is the largest airport in the Netherlands, and one of the largest airports in Europe. It has one terminal building and 6 runways. The full aerodrome ground movement layout of Schiphol Airport can be found in chapter 3. The only terminal building is located at the center of the airport and has several piers attached to it. These piers provide a direct route from the terminal to many of the gates. In total 91 out of the 220 aircraft stands are directly connected to the terminal. [30] All aircraft go through the same flow when arriving and departing from Schiphol Airport. This flow is visualized in Figure 2.1. For this study, the interesting part of this flow is when the aircraft is controlled by the ground controllers, which happens when it is maneuvering between the apron and the runway. The taxiways and runway locations are therefore important within this phase, which is why they are discussed below.

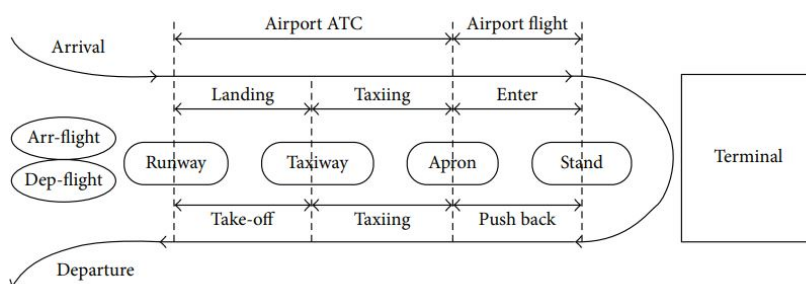

Figure 2.1: Ground operations Aircraft flow [26]

### Runways

At Schiphol Airport there are six different runways used in daily operations. Three of these runways lay parallel to each other, all in the north-south (18/36) direction. From west to east they are called the Polder Runway, Zwanenburg Runway and Aalsmeer Runway. The other three runways are the Buiterveldert Runway (09/27), Schiphol East Runway (04/22) and the Kaag Runway (06/24). All runways are located close to the terminal area, except for 18R/36L which is located at a considerable distance west from the terminal. This distance is large enough that runway 18R/36L has its own air traffic control tower called Schiphol Tower West (TWR-W), which is located at the south-east end of

18R/36L. The main air traffic control tower is called Schiphol Tower Center (TWR-C) and is located on the west side of the terminal building. From this tower, the remaining five runways are clearly visible to air traffic controllers.[45] All runways at Schiphol are roughly the same size, with two exceptions. Runway 04/22 is considerably smaller than the other 5 runways, and runway 18R/36L is considerably wider. [30] The overall layout of the runways can be seen in Figure 2.2 as well as Figure 2.3.



Figure 2.2: Runways Schiphol Airport [48]

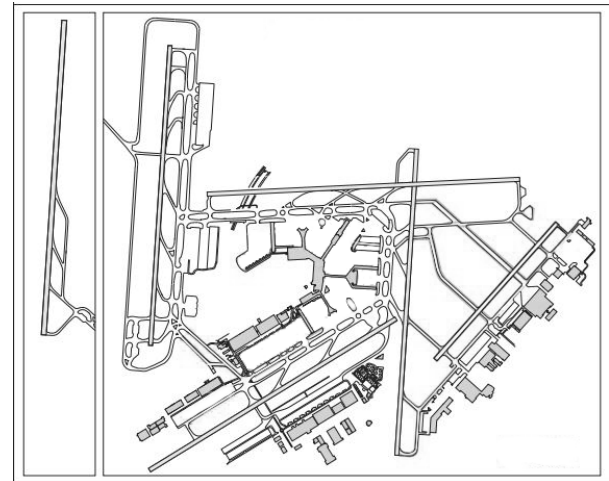

Figure 2.3: Lay-out Schiphol Airport [45]

## Taxiways

The two most important taxiways at Schiphol Airport are taxiways Alpha and Bravo. These are the two taxiways that form a double circle around the terminal. The standard taxi direction on Alpha is in a clockwise direction, and for taxiway Bravo this is in a counterclockwise direction.[45] These taxiways almost go around the entire terminal area, except for the southwest corner in which they are disconnected. Taxiway Quebec connects the different taxiways and creates a circular connected system. Taxiway Quebec is a single-lane taxiway and is therefore only used in one direction. This direction is dependent on the runway configuration used at that specific moment. Schiphol is currently building a second taxiway parallel to Quebec that will create a circular parallel taxiway system where taxiway Alpha and Bravo go entirely around the central terminal area.[31] Next to Alpha and Bravo two more taxiways have a standard taxi direction, namely taxiways Charlie and Delta. These taxiways are located on the east side of runway 18C/36C and lay parallel to this runway. These two taxiways are connected to Alpha and Bravo and have a similar way of determining the standard direction, which is that the aircraft should drive on the right lane from their perspective. To connect this main taxiway system to the far away runway 18R/36L three taxiways are in operation. Taxiway Yankee is used to move around 18C/36C in northern direction, while taxiway Zulu is used for passing this runway in southern direction. Crossing 18C/36C directly can be done via taxiway Whiskey 5. All these taxiways converge on the west side of 18C/36C and continue as taxiway Victor. [45] The taxiways at Schiphol airport are shown in Figure 2.3. Next to this, they are shown in more detail in chapter 3.

All runways are connected to rapid runway exits, except for the smaller runway 04/22. These rapid runway exits make it possible for an aircraft to exit the runway at a higher speed, which means the runway is cleared quicker leading to a better traffic flow. A significant number of the runway entrances and exits are directly connected to taxiway Bravo.

## 2.2. Runway capacity & configurations

This section discusses the runway capacity and configuration, as well as all parameters that are of influence to this. The runway capacity will be discussed first, as there needs to be capacity on a runway for it to be included in the runway configuration. Then the selection of the runway configuration is discussed, followed by the frequency in which the different configurations occur at Schiphol Airport.

## Runway capacity

Runway capacity is dependent on several parameters. The ones that will be discussed are the meteorological conditions, as well as the wake turbulence and aircraft mix. These parameters determine whether the runway can be actively used, and what the amount of air traffic movements can be in a specific window of time.

### Meteorological conditions

When determining which runways are available at a certain moment in time, the meteorological conditions are an important parameter to take into account. When considering the meteorological conditions the main two parameters to check are the wind and visibility conditions. [46]

Wind direction and wind speed are essential for determining if a runway is fit for landing and take-off. For an aircraft it is desirable to take off and land with a headwind as it reduces the landing and take-off speed.[23] Landing or take-off with crosswind is allowed at Schiphol airport, but with crosswind speeds higher than 20 knots the runway is no longer recommended for use.[46] Figure 2.4 shows the wind rose of Amsterdam Schiphol Airport, in which the most dominant wind directions can be seen. The most dominant wind direction is the direction southwest south. This means that at dominant wind conditions only runway 09/27 would be unfit to operate.

Concerning visibility, two types of conditions can be present. The first one is Visual Meteorological Conditions (VMC) and the other one is Instrumental Meteorological Conditions (IMC). Under VMC the pilots are ought to have sufficient visibility to maintain visual separation with the ground and with other aircraft. Under IMC this is not the case and pilots will primarily need to use their flight instruments. An aircraft is under IMC when the visibility is less than 3 miles ( $\approx 4.8$  kilometers) and the cloud base is less than 1000 feet ( $\approx 330$  meters). [46][2]

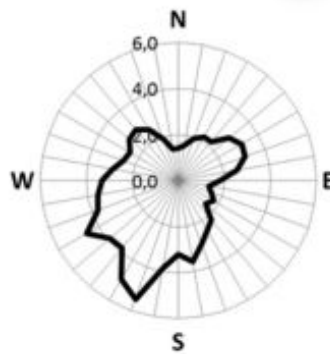

Figure 2.4: Schiphol Airport Windrose [18]

### Wake turbulence and aircraft mix

Due to wake turbulence, there is a minimum separation distance between consecutive flights. This has an influence on runway capacity as it means an aircraft cannot take off or land immediately after the previous aircraft. Wake turbulence is a disruption of the air behind an aircraft, which is generated by every aircraft while they are in flight. It is generated at the wingtips of an aircraft and results in two counter-rotating vortices that trail behind the aircraft. This creates the air behavior in which the air between the vortices moves downwards, while it moves upwards outside of the vortices. [34] The strength of a vortex is dependent on aircraft parameters like weight, wingspan, wing shape and speed. The highest vortex strengths are created when heavy aircraft are flying slowly. [28] Due to safety regulations there are certain separation distances that air traffic control should keep between consecutive aircraft on a specific runway. The minimum distance between two aircraft flying in sequence is dependent on the aircraft size of both aircraft. When a light aircraft is flying behind a heavy one the separation distance will be larger than when a heavy aircraft is flying behind a light one. [62][37]

The separation distance is dependent on the types of aircraft, so the runway capacity itself is therefore also dependent on the mix of aircraft types. The separation distance is always smaller when aircraft of the same aircraft type are flying behind each other, while the separation becomes larger when the aircraft are of different types. [62][37] The runway capacity can therefore be influenced by the sequence in which different aircraft take off. This does mostly affect take-off runways as the inbound

traffic sequence cannot be influenced as easily as the outbound sequence.

### Configuration selection

Schiphol as an airport has relatively many runways compared to other large European airports. [33] Due to the number of runways there are a large number of runway configurations possible at Schiphol Airport. There are several reasons for choosing a specific runway configuration, or for changing to a specific runway configuration. First of all, a runway needs to be available and have enough capacity, so no maintenance must be planned, no accident must have happened and it must not be snowed in. Secondly, some runways are never in use or are only in use during the daytime. Runway 18R and 36R are never available for departures, while 36L and 18L are never available for arrivals. Between 22:30 and 06:30 only 06, 18R and 36C are used for landings, while only 06, 18C, 24 and 36L can be used for take-off. During this period no more than one landing and one take-off runway may be active. [43][41] Finally, there are still two aspects that would determine which of the remaining runways will be part of the active runway configuration. [48]

### Traffic density

At Schiphol Airport the number of runways used is dependent on the traffic volume of the inbound and outbound flights. During off-peak hours two runways will be active, of which one is used for take-off and the other for landings. Three runways will be used during the inbound and outbound peaks. During the inbound peak, two runways will be used for landing and one for take-offs, and during the outbound peak two runways will be used for take-offs and one will be used for landings. It might happen that the inbound and outbound peaks lay very close together or even overlap slightly. In this case, four runways are active, two meant for landings and two for take-offs. [3] On an average day at Schiphol the inbound configuration will be used five times, while the outbound configuration will be used 6 times.

### Environmental rules

When the current meteorological situation as well as the traffic density creates a situation in which there are multiple configurations available for selection, the preferred sequence will determine which runways will form the active runway situation. [47] The preferred sequence is the sequence in which runways will be chosen based on noise pollution. The area north of runway 18R/36L as well as the area southwest of runway 06/24 are areas that are less densely populated. This means that when there is a northern wind runway 36L is used for departures and runway 06 is used for arrivals. At peak times runway 36C can be used as the second departure runway and runway 36R can be used as the second arrival runway. When there is a southern wind the same construction is used but with runway 36R as the main and runway 36C as the second arrival runway. Runway 24 and runway 18L will then be respectively the main and second departure runways. [32]

### Configuration frequency

The following runways are most frequently used as landing runways, 06, 18R, 36R, 18C, 36C, 27. And the departure runways most frequently used are 36L, 24, 36C, 18L, 18C and 09. [43] Information on what configurations are used most is very scarcely available. Luckily Air Traffic Control the Netherlands provided a data set of all runway configurations used between the beginning of May 2019 and the end of September 2019.

For this study the configurations in which only two runways are used are not interesting, as these are used off-peak and during the night, which are the moments in which the ground controller task load is low. This means that only the configurations with three or four active runways in them are considered in this analysis. For all moments in which any of these configurations are used within the time span of the above-mentioned five months, the duration that the configuration is actively used is logged. Using this information a ranked list can be made of the configurations that are used most often. This rank can either be based on the number of occurrences in the time span or on the total duration in the time span. The ranked list based on occurrence can be seen in Figure 2.5, and the ranked list based on total duration can be seen in Figure 2.6. The five most used runway configurations are the same for both of these criteria, and these configurations together are used over 50% of the time when at least 3 runways are active in the used data set. From this data the number of runway configuration changes can be deducted. This number of configuration changes is found to be 15.8 per day at Schiphol Airport.

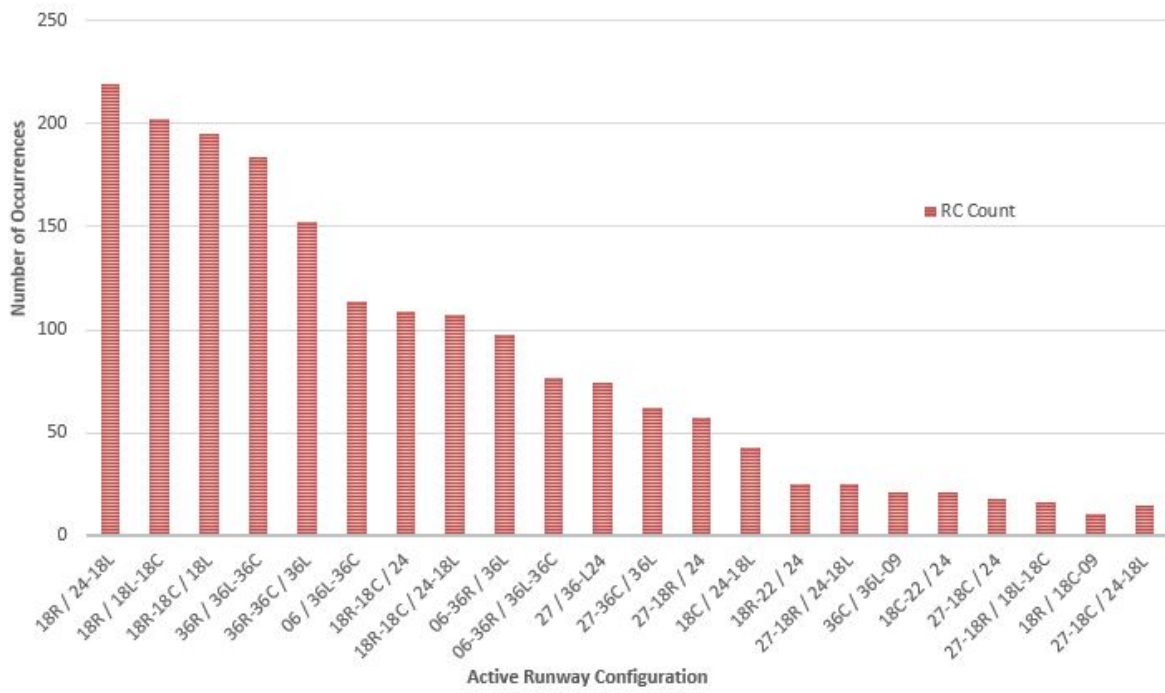

Figure 2.5: Configuration Rank based on occurrence

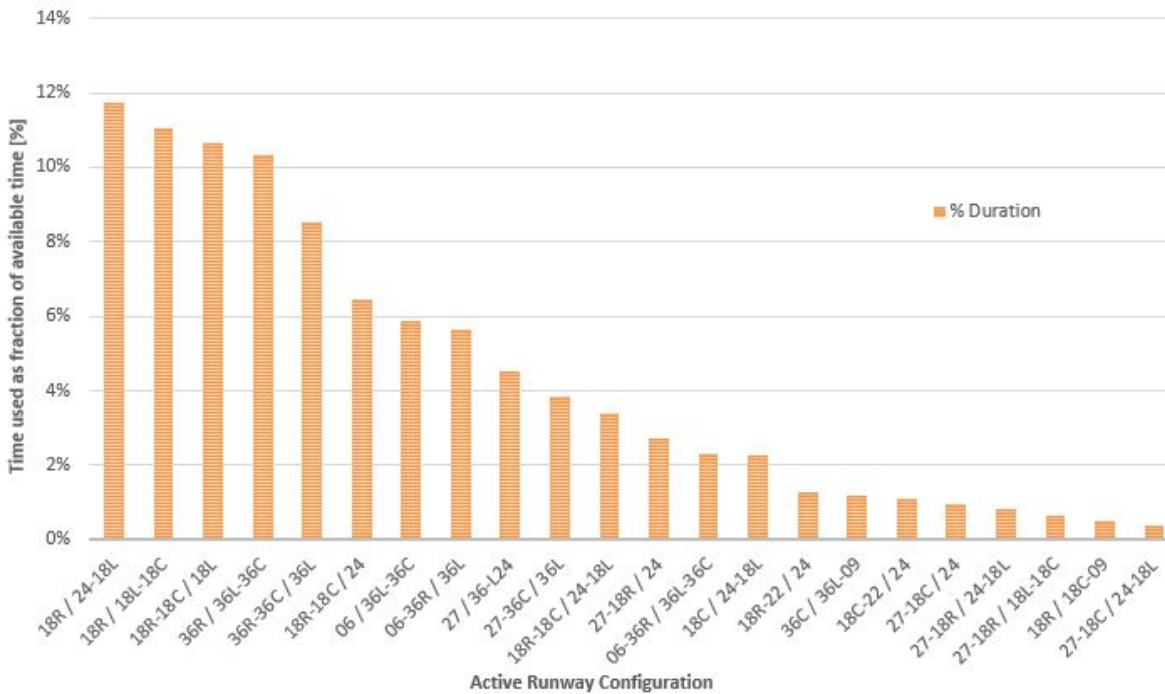

Figure 2.6: Configuration Rank based on duration



## Ground Control at Schiphol Airport

This chapter will discuss the important aspects of ground control operations at Schiphol Airport. These include the responsibilities and goals of a ground controller, as well as the workplace of a ground controller. The workplace consists of both what equipment a controller uses as well as what communication lines the controller has during operation. Next to this, the ground control sector division at Schiphol Airport is discussed.

### 3.1. Controller responsibilities and goals

A ground controller is the air traffic controller that an aircraft will communicate with between Apron Planning & Control (APC) and Schiphol Tower Control (TWR). This means the aircraft will communicate with ground control between pushback and entering the runway for outbound flights, and between exiting the runway and parking for inbound flights. The ground controllers will be responsible for all aircraft that are within these points in time, which is called the taxi phase. So a ground controller is responsible for handling all movements that happen in the maneuvering areas. Movements on and onto an active runway are excluded for this. [19, p.319][41] On Schiphol Airport the official responsibilities of the ground controller are to provide Aerodrome Control Service, Alerting Service and Flight Information Services to aircraft, towing traffic and other vehicles moving inside the maneuvering area. [49][41] While the towing traffic is the responsibility of the ground controller, it is being controlled by APC. These two Air Traffic Control (ATC) divisions are currently located in different locations in the tower. However, the process of placing tow control next to ground control at the same location has already been started. This is done to create a higher shared situational awareness. [44]

The different tasks of a ground controller working for Air Traffic Control the Netherlands (LVNL), as described in [41], are: maintaining communication with all flights under the controllers' responsibility; giving pushback and taxi-instructions; transferring departing aircraft to the runway controller, as well as aircraft crossing an active runway; giving instruction to prevent collisions and unauthorized runway entering; transferring aircraft to another controller when the aircraft leaves the controllers sector; informing aircraft about weather conditions as well as navigational equipment status; assigning remote holding places; operating taxiway lighting and alarming in case of emergency.

The procedure that an aircraft goes through at Schiphol Airport after start-up is as follows. When start-up has been cleared by the Outbound Planning (OPL), the flight strip of that same aircraft will appear on the flight strip screen of the ground controller. The pilot will have to wait until all checks are done and the aircraft is ready for pushback. When the aircraft is ready for pushback the pilot will call this in via the frequency of the specific sector he is currently in. The controller will either clear the aircraft for pushback or tell it to hold until further notice. The pilot will contact the pushback driver after the pushback permission is received. If the pushback did not start within one minute of the permission, the pilot will have to contact the controller to ask for permission again. [42] When the aircraft is cleared for pushback it will get further instructions. These could be to hold after pushback, to hold until a certain other aircraft has safely passed, or to start taxiing. When the aircraft starts to

taxi it will get the route via the controller. Most times the used routes are part of the standard taxi routes at Schiphol Airport, but sometimes other routes are used. The communication between pilot and controller is kept to a minimum when possible, but it often happens that some more communication is needed during taxiing. This could be when an aircraft has priority over another aircraft in a way that does not fit the standard priority rules, or when there is a situation in the maneuvering area. When all goes well the aircraft will reach the runway entry, at this moment the controller will call to tell the aircraft to switch to the tower frequency, thus ending the communication between the two. This is the procedure as it is for outbound flights. For inbound flights the procedure is the same, only the first moment of contact is when the aircraft exits the runway, and the last moment of contact is when the aircraft is parking.

According to various ground controllers who worked for Air Traffic Control the Netherlands, the three main goals of a ground controller are ensuring safety, sequencing and streaming, which are discussed below.

### Ensuring Safety

The goal of ensuring safety is very clear. Due to safety reasons aircraft need to keep a separation from each other on the ground, it is one of the tasks of the ground controller to make sure this separation is maintained during taxiing, as well as on the aprons. To get the best results in sequencing and especially streaming it is also important to avoid conflicts before they heavily affect the traffic flow. When a conflict needs to be resolved before it occurs, it usually means the traffic flow will be disturbed by a sudden change in behavior by one aircraft. Therefore a ground controller will always need to monitor to see if there are potential conflicts occurring in the current field.

### Sequencing

Creating an optimal sequence means delivering the outbound traffic in optimal order to the runway controller. This is needed to maximize the runway usage and therefore the runway capacity. The sequence delivered by the ground controller has an influence on the average time an aircraft will have to wait until it can take off after the previous aircraft. A few factors of influence on this process are the used SIDs in combination with the runway configuration, the wake turbulence categories and the usage of intersections. [41] The runway controller determines the actual sequence used for takeoff, but it is the responsibility of the ground controller to deliver an optimal prepared sequence.

A Standard Instrument Departure (SID) is a specific departure route that is implemented for all IFR-traffic departing from Schiphol. Every take-off runway has several of these SIDs and they are created to make optimal use of the available airspace. Next to this these routes also avoid, where possible, densely populated areas to keep noise pollution to a minimum. These SIDs are connected to the concept of sequencing due to the fact that the SIDs of two consecutively departing aircraft determine the amount of time that needs to take place between the two departures. If two aircraft with the same SID and speed depart after each other from the same runway, a longer waiting time is needed for the second aircraft in comparison with the situation in which the second aircraft had a different SID. This means that for a ground controller it is best to alter the aircraft in the sequence based on their SIDs in such a way that no two aircraft with the same SID will depart directly behind each other.[41]

As mentioned in section 2.2, the runway capacity can be influenced by the order in which aircraft of different wake turbulence categories will take off. This means that the sequence in which a ground controller delivers the traffic directly influences the runway capacity, via the aircraft's wake turbulence category as well as its SID. While creating the sequence it is possible to not only place aircraft at the start of the runway but to let them start at an intersection. This can only be done when it is needed for operational purposes. This means that when a number of aircraft with similar SID's or unfavorable wake turbulence categories are waiting behind each other at the runway start, an intersection can be used to fit an aircraft in between the others in favor of a better sequence. [41]

### Streaming

Streaming is done well when all traffic is moving. The goal of good streaming is that all traffic can move through the maneuvering area with as little delay as possible. To accomplish this, moving aircraft are preferred above stationary aircraft, even when the moving aircraft are somewhat diverted from the most optimal route. This is due to the fact that a moving aircraft is a lot more flexible than a stationary aircraft. The larger the aircraft, the longer it takes for it to start moving after being stationary, which

means that for streaming it is always best to keep heavy aircraft moving and to stop smaller aircraft when needed, because those will be moving again sooner after being stopped.

### 3.2. Sectors

At Amsterdam Schiphol Airport the ground controllers are located in two different towers. At the maximum occupancy, there are three ground controllers operating at Schiphol Tower Center and one ground controller at Schiphol Tower West. At Schiphol Airport the handling of ground traffic is divided into geographical regions. In the scenario in which there is enough traffic that all 4 ground controllers are needed, the airport is divided into 4 sectors. These sectors are Ground Control North, Ground Control West, Ground Control South and Ground Control Center. Ground Control North is the biggest sector as it contains the three runways 04/22, 09/27 and 18L/36R. Ground Control South contains runway 06/24 and Ground Control Center contains 18C/36C. The last sector Ground Control West contains the far away runway 18R/36L. [49, p.13][41] This is all visualized in Figure 2.1 The controller that is responsible for the sector Ground Control West is always active when the runway 18R/36L is used. This controller is the only one that is located at the Schiphol Tower West, which is due to the fact that runway 18R/36L is located too far away from the main body of Schiphol to be visible from Schiphol Tower Center.

The four sectors are not always all active. Since runway 18R/36L is one of the most used runways [43], the sector Ground Control West is often active. In periods with a lower traffic throughput, the other three sectors can be handled by one controller. Often when the traffic volume starts to increase the decision is made to work with sector Ground Control North and sector Ground Control South. Sector Center can then be divided into these two sectors. Sector Ground Control Centre is mostly used when the traffic volume is very large while runway 18C/36C is active.

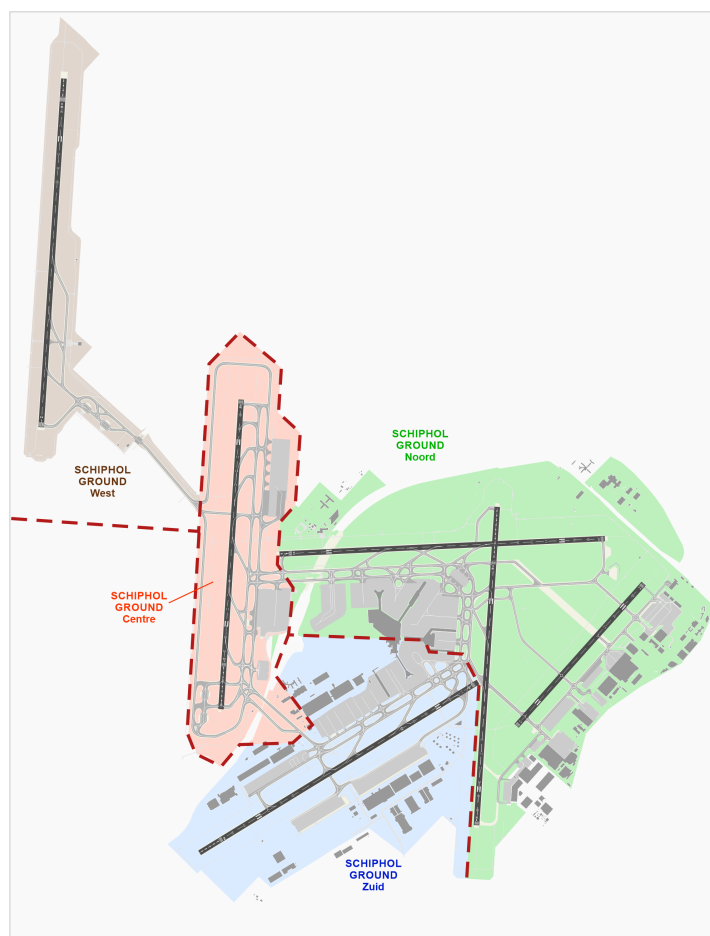

Figure 3.1: Ground Control Sectors [41]

The sector configuration is changed depending on the number of controllers active, as well as if the west and center runways are actively used. However, the overall structure stays the same. There are however some small areas in which the sector configuration can temporarily change during operations. Two common ones that can be changed when the traffic situation asks for it are the following. The first one is the taxiway Quebec, located on the southeast end of the center sector. This sector can be placed in the center sector or the south sector, depending on which one has a higher traffic load. The same holds for the D-pier, which is the tuning-fork-shaped pier on the northern border between the south and north sector. This area can also be placed either in the north or the south sector, depending on the traffic load. These small temporary changes can be made within the tower by the ground controllers themselves and their supervisor, and are therefore not logged.

### 3.3. Controller workplace

Within this section, the workplace of the controller is discussed. This means the physical place and all the equipment used by a controller, as well as the communication lines a controller uses during the job. Next to this the transferring of shifts between different ground controllers is discussed in this section.

#### Tower entities

Within the tower, there are a lot of controlling entities next to the ground controllers. Together they control everything in the maneuvering area, as well as the Schiphol Control Zone (CTR). All roles within the TWR-C that have a link with the ground controllers will be discussed.

#### Tower Supervisor (SUP)

The Tower Supervisor (SUP) is the responsible actor for the entire tower process, meaning the main goal for the SUP is to deliver all ATC services for the maneuvering area and the CTR around Schiphol Airport, while making sure these services are delivered in a qualitative manner. Some of the most important tasks of the SUP are the following. Firstly, monitoring all actors working within the tower, which therefore includes the ground controller. As the SUP is ultimately responsible for the tower process, it is important for the SUP to be up-to-date with the state of this process. This is not only done by monitoring the other actors, but also by coordinating with them. Secondly, the SUP has the ultimate responsibility for all major decisions that need to be made regarding the tower process. This includes reacting to weather predictions and setting out the strategy in emergency situations. The last important SUP task to mention is the determination of the to-be-used runway configuration. However, this is not the responsibility of the Tower Supervisor (SUP) alone, as the configuration is decided in coordination with the approach supervisor and the Flow Manager Aircraft. The approach supervisor has a similar role as the Tower Supervisor (SUP), but executed within Approach Control. The Flow Manager Aircraft is responsible for a lot of the airside aircraft operational flows. [52]

The communication between the ground controller and the SUP is face-to-face, as both the ground controller and the SUP are located on the 12th floor of TWR-C. Communication between the two happens frequently while not being considered one of the more intensely used communication lines for a ground controller. The SUP is active during the day. During the night, a SUP is on standby, meaning a SUP can be made available when needed.

#### Runway Controller (RC)

The runway controllers are responsible for delivering the Air Traffic Control services around the landing area, which at Schiphol Airport comes down to the runways and their exits. The runway controller fits in the ATC chain between Ground Control and Approach Control. An aircraft will be handed over by the ground controller to the runway controller when it is in line for take-off at one of the runway entries. The approach controller will hand over the aircraft then it exits the Terminal Maneuvering Area (TMA) and enters the CTR. The runway controller will hand over the aircraft at the reversed moments, which are after exiting the CTR or while exiting the runway, to Approach Control and Ground Control respectively.

The runway controller has a large number of tasks, of which the most important ones are the following. Firstly, the prevention of collisions between aircraft, while controlling the inbound and outbound traffic in a safe and efficient manner. For the runway controllers, this traffic consists of aircraft in the landing or take-off phase. Secondly, just like the ground controllers, the runway controllers also provide

Flight Information Services and Alerting Services. Next, the runway controllers are responsible for the active runways, and therefore need to grant permission to whoever wants to cross one of the active runways. The ground controllers, as well as the second tower assistant, can ask for this permission. [52]

The runway controllers have two different frequently used communication lines, which are with Ground Control and Approach Control. For this research, the ground control communication line is far more relevant. This communication happens face-to-face, as both the ground controllers and the runway controllers are located on the 12th floor of TWR-C. Normally, this communication consists of requests to cross the runway. But several other situations might also request further communication. This might be when there is an abnormality on the taxiways, and certain runway exits are no longer preferred.

### **Outbound Planning (OPL)**

The role of the Outbound Planning within the tower process, is to create the optimal starting planning for all outbound traffic. This activity has a large influence on the outbound traffic flow, and therefore on the ground controllers. The outbound planner determines the times at which an aircraft should be ready for start-up because the outbound planner will hand over the aircraft to the ground controller at this point. The majority of the outbound traffic will request a start-up in the outbound peak, and the outbound planner will determine the distribution of these start-up requests over the peak period. [52]

The outbound planner is, like the ground controller, located on the 12th floor of TWR-C. The communication between the two is done face-to-face, and the communication link is one of the most intensely used for the ground controllers. However, it should be noted that the communication will happen with the ground controllers who are controlling the North or South sector, as these are the sectors from which outbound planning will originate.

### **Tower Assistant 2 (TWR ASS-2)**

The Tower Assistant 2 (TWR ASS-2) is another actor situation on the 12th floor of TWR-C. The role of the TWR ASS-2 is to support the runway controller, as well as to communicate on behalf of the runway controller and the ground controller with certain entities around the airport. These entities are the controllers in Schiphol Tower West, the drivers of vehicles in the maneuvering area and airport services or emergency personnel. Next to this the TWR ASS-2 can control the vehicles in the maneuvering area, this does however happen under the responsibility of the ground controllers. [52]

The communication taking place between the TWR ASS-2 and the ground controller is intensive, and happens face-to-face. The communication often consists of informing one of the two of what the TWR ASS-2 is doing, or should do.

### **Apron Planning & Control (APC)**

Apron Planning & Control (APC) is the first and only role discussed in this section that falls under the umbrella of Amsterdam Schiphol Airport instead of LVNL. APC is therefore not located on the 12th floor of TWR-C, where all the above-mentioned roles are located, but on the 10th floor. This means that the communication link with ground control goes via line communication. [52] This communication line is regularly used and is often initiated from the APC side.

The role of the APC consists of Apron and Planning responsibilities. With respect to ground control and this research, only the Apron responsibilities are relevant. The most important responsibility is the efficient and safe handling of the towing traffic. The towing traffic consists of smaller vehicles that tow aircraft when they need to move from one end of the airport to another, without taxiing. In the end, the responsibility of all moving entities in the maneuvering area lies with the ground controllers, but the apron controllers handle the towing traffic. This is where the shared communication will take place, as the apron controller might need to ask permission from the ground controller to cross certain parts of the maneuvering area. [52]

### **Coordination with ground control**

In the above sections the different roles that are connected in the operation to ground control have been discussed. All these have a direct communication link with the ground controllers. It has to be said, that even the most intensively used communication links are still not actively used very often. This is due to the fact that most of the communication is now automatic. When TWR-C still used paper flight strips every aircraft had to be transferred physically to the other controller, which meant there was a lot of communication needed. Currently TWR-C and TWR-W use electronic flight strips, which cancels

the need for this type of communication. An aircraft can now be transferred to another controller without communicating with that controller. This heavily reduces the communication needed between the ground controller themselves, as well as between the ground controllers and either the runway controllers or the outbound planner. This means that there is no communication link in use that is used intensely. The most-used communication happens between the ground controllers. They will need to communicate when a problem occurs that influences the traffic flow in the other sectors, or when they are considering rearranging the active sectors.

### Workplace

At Tower Centre the ground controllers have a clear view of all runways except for the far away runway 18R/36L. Next to this almost all taxiways, apron areas and gates that lay east of runway 18C/36C are visible. All working stations for the controllers are placed in a way that from that location the sector under control is clearly visible.

There are several digital tools located at a controller workplace, which enhance the situational awareness of controllers, as well as the overall safety of the operations. These different tools come in the form of multiple screens with information shown on them. One of the screens that has a large contribution in creating a higher situation awareness for a controller is the Airport Surface Detection Equipment (ASDE). The ASDE provides a birds-eye view of Schiphol, with all active vehicles presented by a dot and a label. The needed information comes from different primary and secondary radar sources. Using this screen it is easy to quickly oversee where all vehicles are located and which way they are going when they are moving. It is also an essential tool for when operations are performed with reduced visibility. The radar has an update frequency of one second, so the provided visual is quite up-to-date. Next to the ground radar, the radar screen also provides the radar image of Schiphol Tower Control (TWR). On this screen, all airborne flights approaching the runway are shown, which gives the ground controllers a bit more awareness of the number of aircraft landing within their sector in the next few minutes.

A second screen is used for the digital flight strips, which is a tool used by the ground controllers to keep track of the traffic situation. The layout of this screen consists of multiple columns and rows. The different sections in which a specific flight strip can be located all mean something different for the status of the aircraft. The most important columns are from left to right: the passive column, pushback column, clockwise traffic column, counterclockwise traffic column, and Schiphol-East column. In the passive column, outbound traffic is located that has not yet been cleared for pushback but has been handed over to the ground controller, when they are cleared they are placed in the pushback column that consists of pushback pending and a pushback section. The clockwise and counterclockwise columns are for traffic moving in those directions over the Alpha and Bravo taxiways. So traffic is not divided by which road they are driving on, but by what direction they are driving in. Traffic for Schiphol-East has a different column to keep the general aviation strips separated. These are some of the more used sections. Other sections that are present are for example the section Other, which gives controllers a section to place a strip if the aircraft does not fit any of the other sections. There is a section that transfers the flight strips to another controller, as well as a section in which flight strips appear when an inbound flight has landed and a section where a strip is placed when it is ready to be moved to TWR. The strips also have the functions to write on them in different colors, as well as to move them halfway between columns. This is all done so the controllers can do anything with the strips that make it possible to work in the most pleasant way for them. When an aircraft has parked the strip can just be moved out of the screen. For clarity the inbound strips are yellow and the outbound strips are blue. The logic behind this is that outbound aircraft are headed for the blue sky, while inbound aircraft are headed for the yellow sand. The information that is available on a flight strip consists of the flight number, the inbound and outbound runway as well as the aircraft type and slot time for departure.

These above-mentioned information screens are responsible for most of the information used in a ground control shift, but there are several more screens with useful information. One of them shows which runways are currently active, another one shows the incoming and outgoing flights for the next period of time. The last screen is a touchscreen that is used to control to whom the controller is talking. It can let you select the input microphone, which is used when switching controllers, with this microphone you can talk to all aircraft within your sector at once. Next to this, there is also the option to call APC, TWR and other ground controllers very easily. This is useful at busy moments, in lower traffic moments the communication with Tower Control and the other ground controllers often goes

verbally as they are working in the same room. There are several more information-providing screens at the controller working place, but the ones mentioned above are deemed the most important.

### Transferring shifts

A ground controller shift starts with the transfer, which is split into two parts. The first is self-debrief. This means the starting controller needs to get up to date with some of the general conditions. Some of these are the used frequencies, runway lights, runway conditions and agreements with other factions as for example APC. The second part is the actual transfer. It is important that the starting controller first gets a complete image of everything that is happening. This means the ending controller will debrief the starting controller about any closed roads, diverting SID's, possible emergencies and future runway configuration changes. This ends with the ending controller explaining what still needs to be done concerning current conflicts in the field. The order of telling all this information is specifically chosen to go from broad to small picture. The actual transfer will not be completed until the starting controller has a complete image of the situation. [41]



## Task load

This chapter discusses task load as well as workload, and how these differ from each other. Next to this, the connection task load has with air traffic control complexity is mentioned. For this research task load data is needed, for which different data sources are researched within this chapter. After this an experiment is explained. This experiment was used to research reasons that cause a high task load within ground control at Schiphol Airport.

### 4.1. Workload and task load definition

There are a number of definitions used throughout the literature regarding mental workload. De Waard (1996) [4] used a simplistic view in which workload was defined as the demand that was placed on someone. However, the research itself acknowledged that this is a simplistic view that only looks outwards to the external demands. Rouse et al (1993) [24] argued that workload comes from a specific task or external demand, but that it is also dependent on the specific person conducting this task. A similar view has been shared by Hart and Staveland (1988) [56], who defined mental workload as a combination of the requirements of a specific task, the skills of the operator and the circumstances under which the task had to be executed. Young and Stanton (2001, 2002) [65] defined mental workload as the level of resources necessary to meet the objective and subjective performance criteria. Also, Brookhuis et al (2009) [15] mentions that mental workload is a reflection of task specifications and performer features. Performer features can in this case be a large set of things, such as the motivation for the task, strategies applied to the task, the individual capabilities and characteristics of the performer and even the emotional state of the performer. [63] [17]

From the above literature it can be seen that there generally is a consensus that mental workload is a combination of the specific task load, as well as a combination of performer-based characteristics. Within this study this needs to be translated to the current subject, which is the workload of the ground controllers at Schiphol Airport. The performer is the ground controller, while the specific task load is generated by the traffic that needs to be controlled within the specific sector. For this study, it is not possible to evaluate the performer-based characteristics of the ground controllers, since such thorough research would require a significant amount of time together with the controllers while the task is performed. This is currently not possible at Schiphol Airport. Therefore the part of the mental workload of the controllers that will be investigated in this research is the controller task load.

The task load within ATC in general, as well as in ground control, is often linked with air traffic complexity. This complexity is split into traffic complexity and sector complexity. [55] Within this research the number of sectors used is very limited so these two types of complexity are joined in what will just be called air traffic complexity. Considering that workload consists of the task load and the controller characteristics, ATC task load is based on the geometric nature of air traffic, the static sector characteristics and the operational procedures used to handle this traffic. [11] [55] These two aspects can also be combined into air traffic complexity, making ATC task load be mostly determined by this complexity. This has been previously concluded by Mogford et al [55] as well as Majumdar and Ochieng

(2002). [8] From these researches it can be concluded that air traffic complexity can serve as a very solid estimation of the controller task load.

## 4.2. Task load data

In this report, chapter 5 discusses the concept of dynamic density and the need for task load data within that concept. This section will discuss what types of data could be used as a representation of task load data.

### Potential data sources

There are several sources of task load data that could potentially be used within this research. However, to be acceptable two criteria should be met. Firstly, the data source should have a proven relationship with the task load. Secondly, the data should be available within Air Traffic Control the Netherlands (LVNL), as this is the operational entity responsible for the ground controllers at Schiphol Airport, and therefore the data will need to be requested at LVNL.

Multiple types of data were considered. The first one was a form of activity observers or controller questionnaires. These are famous and often-used methods for finding task load or workload. It can take the form of activity observers, which sit next to the controller and log all tasks that are being performed. This is quite an intrusive method of data collection as it requires an observer to enter the controller workspace while performing the actual task. A less intrusive version is similar, but this time the observer observes the controller while performing a simulated task. In both the actual and the simulated scenario, the task load can also be logged by the controllers themselves after the shift.

The other types of data that were considered for this research were the use of R/T data or flight strip data. Radio Telephony (R/T) is used by the ground controllers to communicate with the moving entities within Schiphol Airport. [52] The most important receivers of this communication are the aircraft in the field. R/T is therefore a vital part of the ground control infrastructure.

The same thing holds for the electronic flight strip system, which was discussed within section 2.3. This system is very extensively used by the controllers, and the data that it logs could be useful as a representation of the task load data. Parameters like the number of strips, swipes and interactions with the screen should represent the task load in some form.

Most of the above-mentioned data sources do not meet the established criteria. Everything that would require extensive sessions with controllers can not be used, as these large numbers of controller hours cannot be provided by LVNL. This means that controller observations as well as self-assessments will not be used in this research. The data provided by the electronic flight strip system does not pass both of the criteria. Within LVNL it was deemed difficult to acquire this data as an external researcher. Next to this, the use of electronic flight strip data as a task load indicator is not proven in the literature. It is a fairly new technique and therefore not yet extensively researched. The last option of using R/T-data is deemed possible. LVNL can provide the needed data, and the concept of linking R/T-data with task load has been researched before. This is discussed in the section below.

### Relation between R/T data and task load

Pilots spend a lot of time communicating via R/T. It is therefore interesting to see if there are R/T parameters that are correlated to the task load of the controller. This is a subject that has been studied before within the Air Traffic Management domain. These researches are not specifically done for ground control, but they are still applicable to the subject since the usage of radio telephony is very similar between the different entities of Air Traffic Management.

First the important R/T parameters are stated and explained. The first one is the total percentage of the available time in which the radio telephony is active. This parameter will be called the Total R/T Time. So when the R/T communication is active for 2 minutes over a period of time of 5 minutes, the Total R/T Time would be 40%. These 2 minutes can however be divided over several different calls within these 5 minutes. The R/T frequency is considered active when the frequency is used, meaning

that controller-to-pilot, as well as pilot-to-controller communication, is seen as active usage of R/T. A second parameter is the number of communication events. This parameter will be referred to as the R/T Occurrence and is also always stated within a specific time frame. So continuing on the previous example, these two minutes of active R/T could be divided over 12 different calls. This means that within the 5-minute interval, the R/T Occurrence is 12. The last parameter to mention is the average duration of an individual communication event, within a specific time period. This parameter is from now on referred to as the Average R/T Time. Within the previous example, the Total R/T Time was 2 minutes, the R/T Occurrence was 12 and this was measured in a 5-minute time interval. This makes that the Average R/T Time is 10 seconds, because 12 calls occurred within these 120 seconds of active R/T time.

Back in 1997, D. Potterfield [54] concluded that Total R/T Time is correlated to the workload of a controller. This was researched by letting certified air traffic controllers control different simulated scenarios. This was done while recording an Air Traffic Workload Input Technique (ATWIT) rating every four minutes. This rating is a rating scale for air traffic management controller workload. The scale goes from 1 to 7, with 1 representing a low workload and 7 representing a very high workload. A critical point of this research is that in over 250 ATWIT ratings, the highest recorded value was around 3.5. This means that in none of the simulations the workload was particularly high, or that the simulated environment lowered the participants' workload.

C. Manning et al (2002) [12] researched all three above mentioned parameters. So the Total R/T Time, the R/T Occurrence and the Average R/T Time were all researched for a correlation with task load. The task load was measured by letting a large group of FAA instructors observe a playback of the displays and data of a real traffic situation. They had the same data available as the controller when the situation originally took place. These instructors then estimated the task load that the controller would have experienced when controlling the situation. This was done using ATWIT ratings. This research concludes that the R/T Occurrence and the Total R/T Time are both positively correlated to the estimated task load. There was no correlation found between the Average R/T Time and the estimated task load. This last conclusion regarding the Average R/T Time is however debatable. This research has a fairly low average ATWIT ratings for the task load estimates. It can be assumed that the Average R/T Time will mostly be correlated to the experienced task load when the task load is relatively high. At these moments there is more to gain from the controller's side to keep the communication events brief, so as to lower the task load.

The research of N. Uclés and J. Garcia (2014) [61] focuses on analyzing the correlation between controller workload and R/T Occurrence, as well as between the workload and the Average R/T Time. The workload has been measured by the Spanish Air Navigation Provider via post-operational logs of the controllers. The data set used is over 800 hours worth of Air Traffic Management data obtained from Madrid ACC. This research shows a clear positive correlation between the R/T Occurrence and the workload values, as well as a negative correlation between the Average R/T Time and the workload values. However, the correlation for the R/T Occurrence is a lot stronger than the correlation for the Average R/T Time.

From these previous researches the positive correlation between Total R/T Time and task load as well as the positive correlation between R/T Occurrence and task load are incorporated into the current research. The search for a correlation between Average R/T Time and task load did not yield the same results in the above researches and is therefore not incorporated into this research.

### 4.3. Experiment

For this specific research, the most important reasons for a high task load within ground control at Schiphol Airport need to be known. Since this is not information that can be found in literature, an experiment needed to be set up. This section describes this experiment.

#### Set-up

### Data sources

For this experiment, three different data sources were utilized. All three of these sources will be discussed below.

#### ASTRA-data

The Airport Surveillance Tracker (ASTRA) is a system that combines different sources of radar to be used by the ground controllers. The ASTRA system uses the radar output of several ground radar installations as well as the approach radar. These outputs are combined and plotted onto the ASDE screen mentioned in section 2.3. The ASTRA data used in this experiment is the data that comes from these radar sources, it is however already combined into one large data set. This data consists of several parameters for every active entity on Schiphol Ground or approaching Schiphol Airport. These parameters are updated every second for all entities since that is the rate at which the radars scan their surroundings. The data is collected from all active entities, which are the aircraft moving on the ground, as well as all vehicles that can move over taxiways. This includes towed aircraft.

The useful parameters that are recorded for every data entry are the following. Firstly the timestamp at which the data entry took place and the x and y values are recorded. The x and y values are taken in meters from Schiphol Tower and can be used to calculate the location of the aircraft in latitude and longitude. Next the flight identification code is logged, which is used to separate the different data entries from each other and assign them to a specific aircraft. Lastly, the flight level and ground speed are useful parameters that are provided as well.

#### Runway configuration data

This data source is very simple. It shows what runway configuration was used in what interval in time. From this data the active runways as well as the times at which a configuration change took place can be deduced.

#### Radio Telephony data

The R/T data shows the usage of the four different ground control frequencies used at Schiphol Airport. Each of these frequencies is used within a specific sector, and are used to communicate with the aircraft in the field. This makes this R/T data a good source of the amount of communication needed with the aircraft in the sector at a specific time. The data is built up in the following way. For every R/T call the starting time, the call duration and the frequency are logged. When two ground control sectors are combined, the frequencies are joined. This can be recognized by the fact that the calls will have an identical starting time and duration. This data source is also used to determine what sectors were active at a certain moment in time.

### Data processing

The data processing was done on the Airport Surveillance Tracker (ASTRA)-data. Since the ASTRA data gives the speed and the location of an aircraft on and around Schiphol Airport, a lot of useful parameters can be calculated from this data. However, it is first needed to know what information would be useful for the experiment. Since the experiment is about recognizing what the cause of the high task load was, it would be useful to have information on how many aircraft were in the different sectors, and what phase of the flight they were in. With this in mind, the following parameters were calculated. This was all done in intervals to make it more accessible for the OE's.

Firstly, the number of aircraft in the different sectors was counted. This was simply done by looking at their location in the ASTRA-data, and recognizing what coordinates belong to what sector. Secondly, the number of active aircraft in the different bays was counted. An aircraft was seen as active after pushback for outbound aircraft and before parking for inbound aircraft. Next, the number of aircraft on the runways was counted per runway and it was noted if it concerned a landing or a take-off. Lastly, the traffic on the different main taxiways was counted. All of these parameters were calculated for every interval, and this was done for only inbound aircraft, only outbound aircraft and for all aircraft combined.

Next to these processed parameters a tool was created on which the ground traffic during the moments of interest could be visualized. For this tool the open-source air traffic management software BlueSky

was used.[36] This is a python-based software in which adjustments can be easily made by individual researchers. The newest version of the original source code was used and extended for this experiment. The alternations made were so the software would be able to read the ASTRA data and plot this. Next to this an easy way to visualize this in such a way that it would resemble the ASDE screen closely was created. A snapshot of what a replay of a specific moment of interest would look like is visible in Figure 2.2.

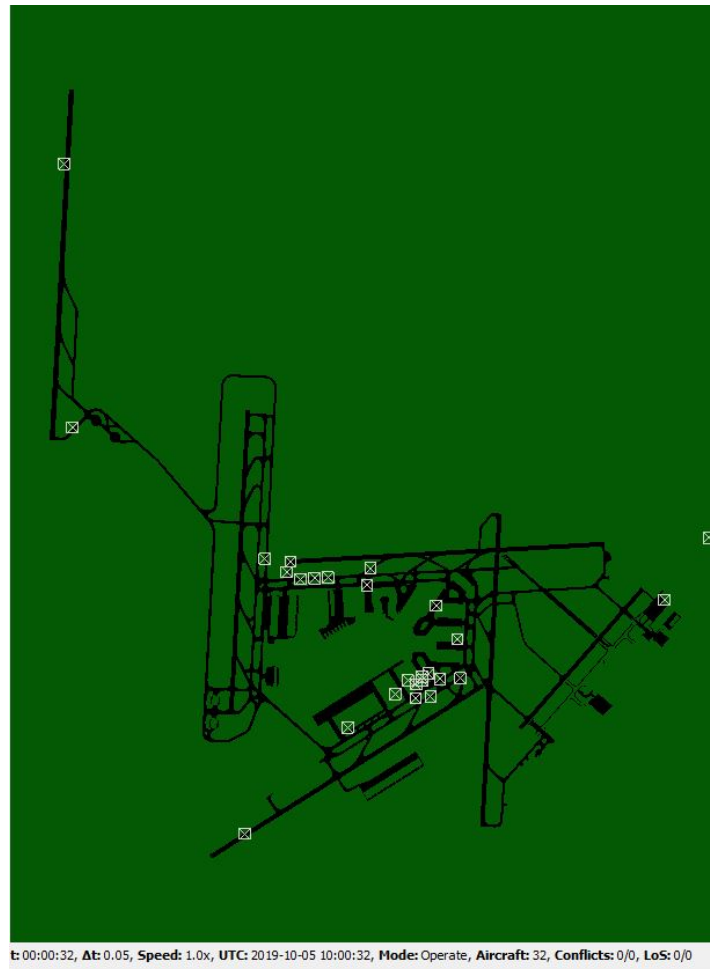

Figure 4.1: BlueSky Experiment Visualisation

#### Data set

As the experiment is in collaboration with OEs it is necessary to make it concise while going over all relevant parts. This means that the data set needs to be limited, while going over all the most important runway configurations. So for the data set six days were selected of which the R/T data, the runway configuration data and the ASTRA-data were made available, and for which this ASTRA data would be processed. The six different days were selected on their runway configuration which were the following. One day, 9-7-2019 was selected for the northern runway usage, while using runway 06. For the southern runway usage, 18-7-2019 was selected. 2-7-2019 was selected due to the fact that landing was done parallel on runways 36R and 36C, while 9-9-2019 was selected on it parallel starting on runways 18L and 18C. 7-7-2019 was added to the data set because of a lot of landing aircraft on runway 27. Similarly, because a lot of starting from runway 09, 5-10-2019 was added as the final day to the data set. These different days were selected due to their varying runway configurations, which were decided on together with the OE's. These different days form a set in which all important runway configurations are represented, or a slight variation on the configuration is represented.

### Experiment execution

The experiment was executed as follows. First of all the R/T load was used to recognize moments in time at which the task load was too high. Together with the OE's it was decided that when the R/T load was above 80% for over 10 minutes, the moment would be interesting to research further. This value of 80% was used as this is the value at which LVNL categorizes the R/T load as very high. Since LVNL is the executive entity for the ground control at Schiphol Airport this value of 80% will also be used within this research so it uses the same definition for high task load. All the points in time at which this happened were grouped and discussed together with the OE's. This meant that the processed data with the parameters like amount of aircraft in the field were analyzed, after which the accelerated playback of the situation was analyzed. After which the group discussed what the possible reason could have been for the high R/T load, which meant that the OE's would walk the group through what exactly happened. After all the moments of high R/T load were discussed, the different reasons were analyzed to see which were the most prominent.

### Results

During the experiment there was enough time to elaborately discuss eight moments at which the task load was deemed critical. These eight moments took place along five of the six days that were selected. In one of these moments there was no real cause found for the high task load besides the amount of traffic being high. Since it was deemed that the controllers did everything as they should have, this moment was categorized as having a justified high task load. For the other seven moments this was not the case, and two different causes were identified that helped to create a high task load situation, which are all discussed below. First, the activation of the center controller is discussed, after which the outbound planning distribution is debated.

#### Center controller activation

The number of ground controllers working at Schiphol Tower is not constant. At night when there is very little traffic, there is one controller controlling all three sectors. During the day the north and south sectors are almost always active, meaning at least two controllers are active. In this configuration, the center sector will be merged with the north or the south sector. When the traffic situation asks for it the center sector will be split from the north or south sector and a third controller will control the center sector. The decision to split the center sector and work with three active ground controllers is made by the ground controllers based on the current and predicted traffic situation. There are runway configurations in which the center controller is required to be active according to the procedures, which are the runway configurations in which runway 18C/36C is used for take-off or landing.

When stating that a cause for a high task load can be the activation of the center controller, this could mean the following things. Firstly, the sector could not have been split, while this could have helped lower the controller task load. When for example the center and north sectors are combined, it could be that the controller was experiencing a too high task load because the north sector on its own is providing enough work without merging it with the center sector. In this case, the center sector could have been activated to lower the task load of the controller controlling the north sector. This situation did occur in the experiment. A second situation that would be categorized as task load inducing is when the center sector is split from the others, but too late. In the experiment this also occurred. The reason that this can happen is that the center sector is only split at the moment at which this seems necessary. This means that when the high task load comes unexpectedly or earlier than expected, the center sector is not yet split. The splitting of a sector can happen quite fast but it is not an immediate process, as the standby controller will have to be called and come up two floors within Schiphol Tower. The traffic needs to be transferred and the new controller needs to gain situational awareness. The third form of controller activation that could induce the task load is when the center sector is merged too quickly with another sector. This does not happen as often as in the previous two cases. In this case, the center sector is merged with one of the other sectors, but after the merging, the controller controlling the merged sector ends up having a too high task load, due to the addition of the center sector.

#### Outbound planning distribution

When an outbound peak starts during the day, most of the aircraft that are scheduled to leave early in this period have their pushback in the South sector. This means that this sector will have a high task

load at the beginning of this outbound period. However, this flow of traffic will often drive in the same general direction, as all aircraft will go to the take-off runways. So the large traffic stream will move from the south sector to either the north or the center sector.

Normally this is a process that can be handled by the ground controllers within the limits of accessible task load. The ground controllers do however not determine the moment at which an aircraft calls to notify that it is ready for pushback. This is done by the outbound planners and the gate planners at Schiphol Airport. It often happens that the distribution of the outbound planning is not distributed evenly over the time period for outbound flights. More than once the experiment showed that a very large portion of the total number of outbound flights was planned within the first third of the outbound period. This not only creates a situation in which the task load for the ground controllers is too large, but it also creates a very skewed distribution of this task load within the outbound period. This is due to the fact that when most of the traffic is planned in the first third, the last two-thirds will have a lot less traffic and therefore generate a lot less task load than in the first third of the outbound period.



## Dynamic Density

Air Traffic Control complexity is often seen as one of the core aspects that influence the overall capacity of the different types of airspace. This is due to the heavy influence that ATC complexity has on the controller task load, and therefore on the controller workload, which influences the amount of traffic a controller can control. [55] For this reason several pieces of research have been conducted within the area of ATC complexity, and especially with the relation it has on controller task load. These researches date back quite far with Davis et al. (1963) [13] being one of the first researchers to investigate the relationship between a few chosen ATC factors and the ATC complexity for approach control. Kuhar et al. (1976) [25] identified over 20 indicators related to workload and researched what the impact of the implementation of a new system was on these indicators. In 1985 researcher E.Stein [60] tried to find an actual relation between several airspace parameters and controller task load. From this point in time, dynamic density was slowly introduced as a concept related to air traffic control complexity. This chapter will start with explaining the concept of dynamic density in section 5.1, after which previous research done on dynamic density will be analyzed in section 5.2. After this, the research gap will be discussed and the concept of dynamic density will be specified for ground control, which can be found in section 5.3 and section 5.4 respectively.

### 5.1. Concept

The term dynamic density is used to describe the concept in which the task load generated by air traffic control complexity is quantified via various air traffic control parameters. However, it is also often used analogously to the ATC complexity situation. [40] Within this report the first use of dynamic density will be applied. As mentioned in the introduction to this chapter, there were already a large number of researches performed within the area of ATC complexity, as well as its relation with controller task load. Dynamic density is a concept that comes from several researchers analyzing specific parameters or indicators that are correlated with ATC complexity. The research in dynamic density got momentum when several institutions decided to collaboratively perform multiple researches on the dynamic density metric that would relate best to controller task load. This will be discussed in the next section.

In the different researches the precise definition of dynamic density is always formulated just differently from the previous, however, it often comes down to the following. Dynamic density provides a metric that relates to ATC complexity. This metric consists of a large variety of factors and variables that fall into the two categories of traffic density and traffic complexity. Traffic density is a form of the count of the aircraft within a specific volume, while traffic complexity parameters give a measure of the air traffic complexity in a volume of airspace. [39][14][10] The parameters used in dynamic density are almost always based on traffic data, as this makes that the metric can be used as real-time decision support. [9]

Dynamic density often takes the form of a fairly simple linear summation of measured parameters. The variables used vary between the metrics, but the setup of the formula does not. Every parameter has its own specific weight, through which the importance of some parameters over others can be implemented.

The general formula can be seen in Equation 5.1, in which TP is the traffic parameters, which consist of the earlier mentioned traffic density and traffic complexity parameters.  $W_i$  are the weights belonging to the traffic parameters and DD is the dynamic density value. [14] The weights are taken such that the calculated dynamic density approaches the task load as best as it can. Task load measurements are therefore needed to determine these weights.

$$DD = \sum_{i=1}^n W_i \cdot TP \quad (5.1)$$

The need for the concept of dynamic density has originated from the need to have the ability to measure and predict the ATC complexity, since this is one of the elements needed to predict task load. Being able to predict the task load would be very useful for air traffic control organizations as this gives insight into how many controllers will be needed at certain points in the future. Next to predicting task load, the prediction of ATC complexity can be used when implementing new procedures and when researching future concepts. [10][14][21] At the time of the start of most dynamic density research, the traffic complexity measure used was sector traffic count or peak sector traffic count. [9][10] Both of these are imperfect as there is no difference measured in aircraft flying parallel or aircraft on a collision course, which would obviously generate a different task load.

## 5.2. Previous Research

As said in the previous section, the research in the area of dynamic density got momentum when three institutions started collaborating in their research on the subject. This collaboration started at the end of the 20th century and was formed by the FAA William J. Hughes Technical Center (WJHTC), the NASA Ames Research Center and Metron Aviation. These different originations all made their own dynamic density metric with different variables, after which one unified model was created and tested together with the others. [21] The researches belonging to these three organizations are discussed below.

The NASA Ames Research Center had multiple researchers performing research for the project. Laude-man et al [14] were one of the first to propose a metric that includes the traffic density and traffic complexity parameters. Their hypothesis was that using this variety of factors measured controller task load better than using only traffic density parameters, as was the standard at that moment in time. The dynamic density metric proposed consisted of one traffic density term and eight traffic complexity terms. These complexity terms were focusing on aircraft changes (in altitude, velocity and height), on minimum distances between aircraft and on predicted conflicts. Activity observations were used as a task load measure, which was used when setting the parameter weights. This meant that observers were observing active air traffic controllers performing their normal day-to-day job while recording the count of activity events during specific intervals. The weights were then computed using unit weighing, subjective weighing and multiple regression analysis. Of these three the multiple regression analysis weights were the best predictor for air traffic controller activity. The research concludes that the proposed metric for dynamic density was the strongest predictor of controller task load.

The second group of researchers working on dynamic density for the Ames Research Center were Sridhar et al. [10] They took part in the research because they thought there was a need to understand what effect a change in traffic patterns or airspace configuration would have on the controller task load. The objective of their research was therefore to analyze how well their dynamic density metric would be able to predict traffic complexity in the future. The parameters included in the metric were found by interviewing 65 qualified air traffic controllers. From this nine traffic parameters followed, of which one was a traffic density parameters and eight were traffic complexity parameters. Of the complexity parameters, three were based on changes in aircraft heading, speed and altitude, while the other 5 five parameters were based on the distances between all different aircraft. Subjective weighting was chosen for the metric. It was concluded that there was a high correlation between the dynamic density and the actual controller activity levels. The correlation was significantly better while using the dynamic density than by simply using traffic count.

The final research group from the Ames Research Center was G.B. Chatterji et al who performed a

similar research in 1997. This manuscript is still not published, but the parameters added to the joint dynamic density project can be found in a summarising paper written by Kopardekar [38], who is the main contributing scientist researching dynamic density within the project on the side of the FAA WJHTC. The parameters determined by this research group were quite different. Part of it was focused more on sector geometry, while others were more concerned with the aircraft mix and the differences between the aircraft in speed and heading. Also the proximity of the aircraft to the boundaries of the airspace was taken along.

The second collaborator within the project was Metron Aviation, who contributed to the program with one study performed by Wyndemere in 1996. [64] Within this research the dynamic density parameters consisted of similar parameters as the previously mentioned researches. Sector parameters and aircraft density parameters were used, as well as different traffic complexity parameters. One of the parameters that has not been mentioned before was the level of knowledge of the aircraft intent. This was a constant value during a simulation and depended on what flight rules were used in the simulation. This could vary from the at that moment used operations to free flight. This was meant as a parameter that would make the dynamic density metric more future-proof.

The last research within the joint project was performed by Kopardekar for the FAA William J. Hughes Technical Center. Kopardekar was one of the leading scientists behind the whole project and performed multiple researches. He was part of the research done by Mogford et al [55], who performed a literature review on factors related to ATC complexity, a research that partly lay the foundation for the created joint dynamic density research project. In 2000 Kopardekar wrote a paper [38] in which all parameters from the joint project were summarised together with five new parameters of his own making. He continued his research together with S. Magyarits resulting in a new paper [40], in which a new dynamic density metric was designed. This was made by combining the different parameters used in the metric of the other researches in the research group. It was found that the dynamic density metrics were a better representation of ATC complexity than aircraft count and that the combined metric performed the best. This model was later altered in 2009 in [21]. This alteration was done with more precise controller task load data, while focusing on the sectors in which the previous model performed the least. The new model worked better in all sectors than the previous one. This paper was the end of the joint dynamic density research.

The above-mentioned joint project might have been the largest study in the area of dynamic density but it was not the only one. A.J. Masalonis et al [9] also researched the modeling of ATC complexity using a traffic characteristics-based dynamic density metric. Their focus was on using this metric to manage the traffic flows within a sector. 12 parameters were chosen by analyzing past research as well as performing structured interviews with eight different traffic management coordinators. The 12 parameters were assessed according to several created logical rules. Two of these were that adding an aircraft to the situation should never reduce the complexity and that moving an aircraft such that its distance to all other aircraft increases should not increase the complexity. The parameters themselves were similar to what was found in the joint project researches.

J.M. Histon et al [35] focused more on how the underlying structure of the airspace was of influence on the ATC complexity. This is a different direction compared to the joint project as in that case the airspace was a constant and the focus was on the traffic inside the airspace. The research by Histon focuses on both the airspace and the traffic and concludes that the layout of the airspace is of importance to the ATC complexity.

C.A. Manning and E.M. Pfeiderer [51] performed a research with the hypothesis that the number of aircraft in the sector alone is an equal or better measure for controller activity. This therefore was a research to prove the joint project wrong as their conclusion was the exact opposite of this hypothesis. The data on controller activity was measured using active controllers and was compared to aircraft count only, as well as a metric that combined aircraft count with eight other parameters. These parameters ranged from aircraft mix to frequency congestion and from given complexity rating to weather. The parameters were therefore very diverse. The conclusion of the research was that the hypothesis was found incorrect, and the complexity metric performed better than aircraft count alone.

A different study that does not directly study dynamic density is performed by Koros et al [7]. This

specific research studies what factors are the cause of complexity in the air traffic control tower, of which ground control is a part. The study took place at six different airports around the US and 62 air traffic control specialists took part in the study. There were 29 complexity factors found in this study that were all contributing to complexity on varying levels. The relative contributions of these factors to the ATC complexity were determined via interviews with the ATC specialists. The factors that were found most trivial to the ATC complexity at the two airports that were most similar to Schiphol, which were O'Hare International Airport and Boston International Airport, are the following. The used runway configuration, the high traffic volume, traffic management initiatives, reduced visibility and frequency congestion. With traffic management initiatives the strategies used to manage the traffic are meant, and with frequency congestion the clogging of the frequency is meant, which means the communication with the pilots becomes more complex.

### 5.3. Research Gap

As can be seen in the previous section, the dynamic density concept has been researched quite extensively. However, this is all done with a traffic set of airborne aircraft. There has not been any researcher that analyzed the dynamic density principle for grounded aircraft, and therefore for ground controllers. The principles of the dynamic density concept would be the same for ground control, but the parameters used would be completely different. Next to this, it is known that dynamic density is a good ATC complexity estimator, but its weights need to be determined for specific the used airspace, as it can not be universally used in different types of airspace. [20] Schiphol Airport currently does not use an objective quantitative way of measuring or estimating the ATC complexity within ground control. A dynamic density model based on traffic parameters, created for the ground control section of Schiphol Airport would fill the research gap that currently exists in the areas of dynamic density as well as ground controller task load. Next to this, the metric can be of great use to answer other task load-related research questions that relate to Schiphol Airport ground control.

### 5.4. Dynamic Density for Ground Control

This section tries to bridge the gap between the dynamic density studies mentioned above and ground control at Schiphol Airport. For this first the important differences between ground control and airborne ATC are discussed, after which several dynamic density parameters are translated to ground control.

#### Ground control vs airborne control

When creating a dynamic density metric in a similar fashion as how the airborne ATC control metric was created, it is necessary to know what makes ground control different from airborne ATC control like approach and area control. First of all the area in which the aircraft is moving around is extremely different. When aircraft are airborne they can often be instructed to go anywhere in the sector by the controller. This gives a lot of freedom when there are conflicts or other circumstances like bad weather, due to which the aircraft need to move around a certain point. This is very different from ground control. In section 2.1 the layout of the ground system of Schiphol Airport was discussed. The area in which aircraft can move around is very restricted, as they can only move over the apron and taxiways. It can also happen that this area is restricted more, for example by an aircraft with technical problems. This all makes this aspect of the solution space smaller when comparing it to airborne control as there is less freedom in which the aircraft can be moved around. This is however compensated by the fact that ground controllers have the option to stop the aircraft, as they can stand still and wait on the taxiways, which is of course not possible for airborne controllers. These aspects are important to consider when researching how well the parameters used in the previous dynamic density metrics for airborne control can be translated to the ground control metrics. Parameters like heading changes, or differences in headings between the aircraft, should be reevaluated for ground control.

Secondly, the influence of runway configuration switches on the traffic flows within the sector is very large within ground control. Since Schiphol airport changes configurations very regularly during the day, a controller will experience multiple changes in the traffic flow structure. Next to this, the traffic flow does not instantaneously switch, so there is a period around the configuration shift in which aircraft are still moving in two traffic flow structures. Something that can also change for a controller

during the shift is the merging and splitting of sectors. This means that the sector that a controller is controlling can become significantly smaller or larger. This mostly happens when the traffic demand is high enough for the third ground controller to become active, or when the demand is low enough for the third controller to be deactivated. This happens very regularly at Schiphol Airport. The size of the different sectors is always the same, meaning that a controller knows what area needs to be controlled when splitting or merging. This aspect of ground control also means that the dynamic density metric needs to give a proper estimation of the task load for all different sector sizes.

The last aspect that sets ground control at Schiphol Airport apart from the airborne control is the traffic itself as well as the flow structure. When an aircraft is moving around within a sector it can have its origin or destination in the sector, as well as neither or both of these. This results in the fact that inbound and outbound aircraft move very close together, or are even mixed in the same flows. This differs heavily from airborne control where inbound and outbound traffic are often separated more. An aircraft can enter a sector when starting up at a bay, when exiting a runway or when taxiing from an adjacent sector. Aircraft can exit the sectors in the same ways, parking at a bay, entering a runway or taxiing to another sector. As said the traffic itself can also differ. Similar to airborne control the aircraft are being controlled, however, the controller is also responsible for towed aircraft. These travel similarly to taxiing aircraft, but their speed range is different as some tow trucks are not powerful enough to reach larger speeds. There is also the possibility of other traffic entering the area, which can for example be emergency medical personnel or firefighters.

### Potential parameters

This section will suggest several parameters that could potentially be used in the ground control dynamic density metric. The parameters can be one of the many parameters that were found in the previous researches, potentially adjusted to fit ground control. There are also some parameters that have been created especially for this study. Those parameters were found while conducting the experiment mentioned in section 2.4 together with ground control operational experts.

Similar to [9], there are some criteria on which the parameters must be assessed. These are the following, some of which are derived from the criteria used by Masalonis et al. [9]

1. The parameters must fit the concept of ground control, and be a potential indicator for task load within this field.
2. They must be able to be determined, calculated or estimated using data sources that are available for this research. The available data sources can be found in section 2.4.
3. It is preferred that the parameters meet the following logical characteristics.
  - (a) Adding an aircraft to the traffic set should not reduce the complexity.
  - (b) Either reducing the area in which the traffic set moves, or increasing the speed of all aircraft in the traffic set should not reduce the complexity.
  - (c) Relocating an aircraft in such a way that is now removed further from all aircraft should not increase the complexity.
  - (d) The orientation and origin of the coordinate system should not influence the parameter.
4. The different parameters should not be too similar. This criterion will however be included after the correlation study has been performed.

There were 13 parameters that fit these criteria, eight of which come from the previous studies while the remaining five came from the conducted experiment and therefore were created by expert judgment. All parameters, as well as a brief explanation and the source, are shown in Table 5.1. All of these parameters are discussed in more detail below.

Table 5.1: Suggested dynamic density parameters

#	Parameter	Description	Source
P1	Aircraft Density	#Aircraft divided by the size of the sector	Kopardekar (2000)
P2	Aircraft Count	#Aircraft present in a sector	Wyndemere (1996)
P3	Aircraft near boundary	#Aircraft that are moving near the sector boundary	Chatterji (1997)
P4	Number of handovers out	#Aircraft handed over to neighbouring sectors	Chatterji (1997)
P5	Number of handovers in	#Aircraft received from neighbouring sectors	Chatterji (1997)
P6	Aircraft distribution	Spread of aircraft over the sector	Shridhar (1998)
P7	Direction variance	The differences in taxi direction for the aircraft	Wyndemere (1996)
P8	Configuration switch	Did the runway configuration switch	Koros (2003)
P9	Controller switch	Did the number of active sectors switch	Experiment
P10	Number of pushbacks	#Pushbacks performed in the interval in the sector	Experiment
P11	Number of landings	#Landings performed in the interval in the sector	Experiment
P12	Bay traffic count	The average number of aircraft in the bays	Experiment
P13	Stationary aircraft	The time in which aircraft are standing still	Experiment

### Aircraft Density & Aircraft Count

The aircraft density and the aircraft count are very straightforward parameters. The aircraft density is the number of aircraft that are active in a sector, divided by the size of the sector. The size of the sector is in the case of ground control the total taxiway length available, since that forms the maneuvering space for the aircraft. The aircraft count is simply the number of aircraft active in a sector. Both these parameters are expected to have a positive correlation with aircraft complexity, as more aircraft in the controlled sector will mean that the traffic flow can get more complicated. The reason that both the aircraft count and the aircraft density are suggested is that aircraft density is one of two parameters proven in previous research that takes sector size into account. Aircraft count is however the most used current indicator for ATC complexity.

### Aircraft near the boundary

The parameter of aircraft near the boundary is the number of active aircraft that are near the boundary on both sides of this boundary. This parameter was introduced in Chatterji (1997) [38] and adjusted for ground control. This means that for ground control the proximity to the sector boundary is measured over the taxi roads as this is the maneuvering space of the aircraft. The absolute distance to the boundary is not interesting since an aircraft can be close to the boundary in absolute terms, while it still needs to move a considerable distance across the taxiways before the boundary is reached. The overall parameter is based upon the concept of area of regard. This is the area, which is larger than the controller sector, to which the controller pays attention. [35] A controller pays attention to these aircraft so it is known what aircraft might enter the controller sector soon. For ground control, this not only means the aircraft that are moving in the sectors that are controlled by colleagues, but also the airborne aircraft that are approaching a landing runway that lays in the controlled sector. It is again expected that there will be a positive correlation between the number of aircraft near the boundary and the ATC complexity. This is due to the fact that the aircraft near the boundary cause extra monitoring and create a more complex overall traffic picture.

For this parameter the distance that an aircraft needs to have to the sector boundary before it is included as an aircraft near the boundary is an important variable that should be chosen carefully. The parameter is therefore analyzed for its correlation with ATC complexity multiple times, in which this distance variable will be varied across the different tests. This is done to see what the value of this variable should be to get the highest correlation with ATC complexity.

### Number of handovers

Within ground control, a handover is considered to be the moment in which an aircraft is transferred from one controller to another. This can be a transfer between two ground controllers, between a ground controller and a runway controller or between the outbound planner and a ground controller. This parameter however only considers handovers between ground controllers, as the other forms of handovers are already incorporated in the other parameters. There are two parameters related to the number of

handovers, and those are the incoming handovers and the outgoing handovers. The incoming handovers lead to aircraft entering the controlled sector, while the outgoing handovers will lead to aircraft exiting the sector. For the both parameters the handover itself is expected to be positively correlated with the task load, as it is an extra task that the controller needs to perform. However, after the handover an entering aircraft will create more task load than an exiting aircraft, which might become visible in the correlation analysis for the handovers themselves.

#### Aircraft distribution over the sector

The aircraft distribution across the sector is the level of distribution that the aircraft have over the sector. This means that if three aircraft are located far away from each other in the same sector it will yield a high level of distribution, while three aircraft very close to each other will yield a low level of distribution. It is expected that this level of distribution will be negatively correlated to the controller task load. This is because the different aircraft will need less coordination when they are all located far away from each other. This is however not a guaranteed correlation as it might be the case that the amount of monitoring performed by a controller greatly increases with a higher level of distribution, as the controller will then need to monitor aircraft all over the sector instead of monitoring a small part of the sector. The calculation of the level of distribution will be done via Equation 5.2, in which  $n$  is the number of aircraft in the sector and  $D_i$  is the distance between aircraft  $i$  and the average aircraft location. [22]

This parameter will also need to be put through the correlation analysis multiple times. This will be done while varying which aircraft are incorporated in the distribution. This will be a percentage of the aircraft closest to the average aircraft location. First, all aircraft will be taken along but then some of the farther away aircraft will be dropped. This is done to see if that influences the correlation with the task load. When there is a cluster of aircraft close together and one aircraft far away, the task load might be lower in this calculation than when that same cluster would be alone in the sector. This means that adding an aircraft will lower the estimated task load, which is something that needs to be avoided and was one of the criteria set for the parameters. This is therefore something to take into account in the correlation analysis.

$$distribution = \frac{1}{n} \sqrt{\sum_{i=1}^n D_i^2} \quad (5.2)$$

#### Direction Variance

The direction variance is a parameter that came up in literature as well as in the experiment with ground control operational experts. The parameter has to do with what the headings or taxi directions are for the different active aircraft in the sector. When all aircraft are moving in the same direction the task load for a ground controller is lower, but if all aircraft are moving in different directions the task load becomes higher. For ground control, this is mostly due to the following. When all aircraft are moving in the same direction in the central part of Schiphol Airport, this will happen on one of the two parallel taxiways. This means that the other taxiway is empty, which makes it a lot easier for the ground controller to achieve the ground control goals, especially the combination of streaming and sequencing. When some aircraft needs to move a few places back in the flow of taxiing aircraft, the controller can just turn this aircraft onto the parallel taxiway, let it slow down a bit and move it back into the flow of aircraft, on the place where it fits best according to the sequence. It also gives the controller a lot more freedom when some other problem occurs. However, when the general directions of the traffic are different, one of the two parallel taxiways will move in one direction, while the other moves in the other direction. This means that the controller will need to monitor the sequencing of traffic better, as there are fewer easy solutions for getting the correct sequence.

The parameter will be defined as follows. Every sector will be divided into a few areas in which the traffic can move in a similar direction, meaning it will be split on the points in which the taxiways change their direction drastically. For every area, the general direction can then be categorized into one of the four wind directions. In an area where the taxiway goes mostly from north to south, all traffic will be categorized as moving in a northern or southern direction. The parameter will then be calculated as the percentage of aircraft moving in one direction compared to all aircraft moving in the area. When it would be 50% it means that the traffic is perfectly split across both directions, while 0%

or 100% would mean all traffic goes the same way. The further away from 50% that the parameter will be, the lower the ATC complexity and therefore task load.

### **Configuration switch**

Runway configuration switches occur very often at Schiphol airport, in section 2.2 it can be found that the number of switches per day is 15.8. The runway configuration used determines how the traffic flows through the sector. This can for example be seen when the runway 18R/36L is either a starting or a landing runway. When it is a starting runway a lot of outbound traffic will drive over the airport from south to north, but if the runway is a landing runway all the inbound flights will move from north to south. This does however mean that when a configuration switches there is a period of time in which these two flows move through each other, generating a more complex traffic picture. In the previous example, it can happen that runway 18R/36L is a landing runway but it will be changed into a starting runway. As soon as the last landing took place, the first starting aircraft needs to be ready for take-off. This means that before the last landing took place, the outbound aircraft will already have started moving according to the structure of the new runway configuration, which means that they drive in the opposite direction from the aircraft that are still landing. It is expected that there is a higher controller task load in this period of time, as the traffic picture will be very complex.

Because the configuration switch has an influence on the traffic complexity before and after the moment of the actual switch, it is important to show that influence in the dynamic density. This means that there needs to be an amount of time before and after the switch in which the weight of the switch is accounted for. Therefore in the correlation analysis, this period of time will be varied to test what an appropriate amount of time of influence is.

### **Controller switch**

When controlling the south or the north ground control sector at Schiphol airport, the traffic picture can change when there is a controller switch. In these switches, the third ground controller will either join or leave the controller spot, so in these cases one of the other sectors might be split or merged meaning it will become considerably larger or smaller. This process will have a significant influence on the traffic, however, it is difficult to hypothesize on whether or not it would be a useful parameter inside the dynamic density metric. This is due to the fact that a change in sector size comes with a sudden change in a lot of the other parameters. This parameter will therefore be taken along in the correlation analysis, but it is expected that this parameter might be linked too much to the other parameters, which therefore goes against the set criteria for the parameters.

### **Number of pushbacks**

The number of pushbacks happening in the current interval is expected to be positively correlated with the controller task load because every pushback requires a certain task for a controller. The amount of monitoring around the aircraft is increased, the aircraft needs to be communicated with and the route across the airport will need to be created. These are quite some tasks that need to happen for every pushback.

### **Number of landings**

Similar to the number of pushbacks, the number of landings in the current interval is also expected to be positively correlated with the controller task load. This is due to the fact that the area close to the runway exit needs to be monitored, as well as that other aircraft need to be instructed to slow down or stop to let the landing aircraft enter the taxiway. Next to this, the controller needs to create a route and communicate this route and the destination with the pilot.

### **Bay traffic count**

The average bay count parameter works as follows. The amount of aircraft that are located in one of the bays is all added up and divided by the number of bays that has at least one active aircraft in them. This parameter is taken into account because when multiple aircraft are moving within one bay it is always a point that needs a lot of monitoring by the controller. However, when there is only one aircraft moving in a bay a lot less monitoring is needed. The expectation is that this parameter is positively correlated to the controller task load.

**Stationary aircraft**

The stationary aircraft parameter is a time-based parameter related to the number of aircraft that are standing still on the taxiways. When an aircraft is standing still on a taxiway it blocks all other traffic from travelling over this taxiway. This can lead to the rerouting of traffic, as well as to a lot of instructing of the traffic. As mentioned in section 2.1, streaming is one of the main goals of a ground controller. Stationary aircraft within a sector are complicate the streaming within this sector. The parameter is represented by the total amount of seconds in a specific interval in which aircraft are standing still. This time is summed per aircraft, so if two aircraft are standing still during five seconds simultaneously, the stationary aircraft parameter will be 10 seconds. It is expected that this parameter is positively correlated to the air traffic complexity.



## Regression Analysis

To create a dynamic density formula that fits the task load data best, it is needed to perform a regression analysis. Regression analysis often consists of the following stages: [6]

- Finding independent variables that could potentially be used to estimate the dependent variable.
- Performing a correlation analysis to see if there is a correlation between these independent variables and the dependent variable, as well as between the different independent variables.
- Selecting the parameters that could be used in the model, based on the correlation analysis.
- Performing a form of interactive model-building regression analysis.

The first step has been performed in ?? and twelve potential parameters were selected, which form the potential independent variables. The dependent variable will be the task load. The independent variables will be taken along in the correlation analysis. The result from this analysis will show which independent variables have a high correlation with the task load, as well as which independent variables are heavily related to another independent variable. From this, a decision is made on which independent variables will be taken along into the regression analysis, which will be interactively built, which means not all variables will necessarily be included in the final formula.

### 6.1. Correlation Analysis

The correlation analysis discussed in this section will be important as it is used to analyze which parameters, that are suggested in ??, will be used inside of the dynamic density model. When a parameter has a high positive or negative correlation with the task load, it will be more useful when used in the dynamic density metric. When a parameter is not correlated with the task load, it will not be needed to take this parameter along in the regression analysis.

A correlation analysis is built on the idea of an association between two variables. It comes down to whether or not a variable changes when another variable changes. A correlation between two variables can be high, meaning that in many cases a second variable has the same or the opposite behavior compared to the first variable. The correlation can also be very low, in which case there is almost no relation between the change of one variable compared to the change in the other variable. [27]

The three correlation methods that are often seen as the most widely used are Pearson's product moment correlation coefficient, Spearman's rank-order correlation and Kendall's tau correlation. [27][5] These will therefore be the three methods that are discussed in this section, after which the most suitable method for this specific research will be selected.

### Pearson Product-Moment Correlation

The Pearson Product-Moment Correlation Coefficient, which will be referred to as the Pearson coefficient, is a measure of the linear association between two different variables. To be able to use it, a data set is needed that has multiple points that all have two variables attached to them, for example a plot of points with an X and Y value. A line is then found that forms the best fit for the two variables for all the points. The Pearson coefficient is then an indicator of how far all points are from the best-fit line. [58] So it tries to find the best linear relationship between the two variables and then indicates how far off from this relationship the actual data is. The best possible obtainable correlation would be when all points lay on the best-fitted line, meaning all data points obey the relationship.

The coefficient can be any value between -1 and 1, and a higher absolute value of the coefficient means that the association is strong. When the Pearson coefficient is positive the correlation between the two variables is positive as well. This means that when one of the two variables increases, the other will as well. A negative Pearson coefficient means that the correlation is negative, so when one variable increases, the other will decrease. A coefficient of 0 would mean there is no association between the two variables, while a coefficient of 1 or -1 would mean a full correlation. As a guideline, it has been proposed that a large correlation takes place when the absolute coefficient is above 0.5, while a low correlation takes place when the absolute coefficient is below 0.3. [58][1, p.135-144]

Several assumptions or rules are taken into account for when the Pearson coefficient method can be used. These six assumptions are the following: [58]

- The used variables need to have a linear scale. This means the scale should either be continuous or when the scale is discrete the size of the steps in the scale should always be equal.
- The variables need to be paired. This means that each data point will need to have both variables attached to it, otherwise these points can not be used in the correlation analysis as they only give information about one of the two variables.
- The different observations should be independent. This correlation method is not suitable for instances in which one data point is influenced by one of the other data points.
- There should be a linear relationship between the two variables. This means that the change in variable A should always result in a certain change in variable B, independent of the value of variable A. When there is no linear relationship between the variables the Pearson correlation coefficient will incorrectly estimate the correlation.
- Within the data there should be homoscedasticity. This means that the differences with the best-fitted line should not become steadily larger or smaller with the increasing value of the variables.
- There should be no large outliers within the data. The method uses a best-fitted line and an outlier has a large impact on the best-fitted relation, meaning that the coefficient itself is heavily influenced by this, as it is an indicator of the overall distances between this line and all data points.

The Pearson coefficient can be calculated via Equation 6.1[5]. In this formula the Pearson coefficient is denoted by  $r_p$ , the two variables are denoted by  $x_i$  and  $y_i$  and the total number of data points is denoted by N.

$$r_p = \frac{\sum_{i=1}^N x_i y_i}{\sqrt{\sum_{i=1}^N x_i^2 \cdot \sum_{i=1}^N y_i^2}} \quad (6.1)$$

### Spearman's Rank-Order Correlation

The Spearman's Rank-Order Correlation coefficient, or Spearman coefficient for short, is a measure of the strength of the association between two variables. It differs from the Pearson coefficient in the aspect that the Spearman coefficient is based on the rank of the variables, whereas the Pearson coefficient was based on the value of the variables. The fact that the Spearman coefficient is based on rank, and thus only influenced by the placement of the variable in the ranking with all other variables, makes it less

sensitive to outliers in the data. Due to the ranking method, there is no need for a linear relationship between the variables. [59][5][27]

The Spearman coefficient can take values between -1 and 1. The strongest correlation is found closest to -1 and 1, while a coefficient of 0 means that there is no correlation. A correlation of 1 means that for both variables the data points are sorted the same when ranked from small to large. A coefficient of -1 means that the two variables are sorted exactly inverted from each other. [1, p.135-144] Just like the Pearson coefficient, the Spearman coefficient has some assumptions or rules that the data needs to comply with. These are the following: [59]

- The variables need to be able to be ranked. This means that the variable needs to be able to only take values that can be ranked among themselves. So numbers can be ranked from high to low, but answers to a satisfactory survey can also be ranked.
- There should be a monotonic relationship in the data. This means that when one variable changes the other should change in a certain direction always. The relation does not have to be linear, but as long as one variable is changing in one direction, the other should also change in that direction. If this is not the case the Spearman correlation coefficient will not suggest the correct level of association. Examples of monotonic relations are a linear or exponential function, a sine function is an example of a non-monotonic relation.

The Spearman coefficient can be calculated according to Equation 6.2. [5] In this equation the Spearman coefficient is denoted by  $r_s$ , the number of data points is denoted by  $N$ , the  $x$  and  $y$  are the variables. The subscripts of  $i, r$  denote that index in the ranked list of variables.

$$r_s = 1 - \frac{6 \sum_{i=1}^N (x_{i,r} - y_{i,r})^2}{N(N^2 - 1)} \quad (6.2)$$

The ranking of the variables is done as is needed for the specific research. Usually that is from small to large, or from bad to good if the variables are not numbers. When multiple variables yield the same value they will receive the same rank. This rank can be calculated by adding up the ranking placements that the values would have occupied if they would be ranked differently from each other. This sum is then divided by the number of variables that it concerned, and the solution will become their ranking. So when three variables are equal while the to-be-decided placement is placed 4, the actual rank they received would be calculated by adding places 4, 5 and 6 together and dividing this value by the 3, which comes from the number of variables that were equal.

### Kendall's Tau

Kendall's Tau is a measure of the strength and direction of the association between two variables. It is easily comparable to Spearman's Rank-Order Correlation, but the methods used are different. Similar to the previous two methods, the Kendall coefficient can take a value between -1 and 1, where those values suggest the strongest correlations while 0 means no correlation. [1, p.135-144] The Kendall coefficient is also a coefficient based on rank, which makes it less vulnerable to heavy outliers.[57][27]

To be able to use the Kendall coefficient, the data needs to comply with some rules. For this method, these rules are the same as for Spearman's Rank-Order Correlation method. [57] To calculate the Kendall coefficient Equation 6.3 can be used. In this equation  $N$  stands for the number of data points,  $r_k$  stands for the Kendall coefficient,  $x$  and  $y$  stand for the variables of specific data points and  $\text{sgn}()$  stands for the sign of a specific value.

$$r_k = \sum_{i \neq j=1}^N \frac{\text{sgn}(x_i - x_j) \cdot \text{sgn}(y_i - y_j)}{n(n-1)} \quad (6.3)$$

### Used correlation method

For the current research one of the above mentioned correlation methods will be chosen. All of these methods are scientifically proven methods, but not all of them are fit for this specific correlation analysis. The variables used in the correlation analysis will be the parameters suggested in section 5.4, which are extracted for the ground radar data. The other variable will be the controller task load data, which for this research takes the form of the number of calls made in a specific interval, or the amount of time in which the communication frequency was used within a specific interval. The correlation analysis will therefore analyze the level of association between the task load data and the various suggested parameters. This means that the chosen correlation coefficient to be calculated should work on all these variables, as well as work on large sets of data.

The Pearson product-moment correlation method is deemed unfit for this research, as the data violates several of the assumptions made for the use of this method. To be able to use this method the variables need to have a linear relationship. Within the analysis itself, it needs to be found what kind of relationship the variables have, but it is assumed that many of the parameters will have a monotonic relation with task load data. An example of this is aircraft count. When a controller controls two aircraft it will have a low task load, but this task load will not increase drastically if the amount of aircraft is doubled to 4. However, when a controller is already controlling 15 aircraft in the sector, the addition of one extra aircraft can increase the task load significantly as this one extra aircraft can have interactions and conflicts with 15 other aircraft. Next to this, the data will most probably deal with outliers, something that can really skew the results of the Pearson product-moment correlation method. For these two reasons it was chosen not to use this method within the correlation analysis.

The remaining two correlation methods are Spearman's rank-order correlation and Kendall's Tau correlation. These two methods use similar techniques and therefore there is not a lot of significant differences that would suggest one of the two is more suitable for the analysis. There is however one large difference that makes the Spearman correlation analysis the preferred method. Spearman's rank correlation method has a computational load of  $O(n \cdot \log(n))$  while Kendall's method has a computational load of  $O(n^2)$ . [27] Since the analysis will be conducted on large sets of data, often multiple times to analyze differences when adjusting certain values, the computational load of the method is very important. This fact makes that Spearman's rank correlation method will be the method that is used within the correlation analysis in this research.

### Statistical significance

When using a correlation coefficient it is important to check whether or not the outcome of the correlation analysis is of any statistical significance. To test this two hypothesis need to be created, a null hypothesis as well as an alternative hypothesis. Within this correlation analysis the two hypotheses will be:

Null hypothesis: There is no correlation between variable A and variable B, so  $r_s$  will equal zero.

Alternative hypothesis: There is a correlation between variable A and variable B, so  $r_s$  will not equal zero.

One of these hypotheses will be rejected by the correlation analysis while the other one will be accepted. The test that is done here is a two-tailed test as the alternative hypothesis does not state a specific direction for the correlation. For the test a significance level needs to be chosen, which is a measure of the evidence of correlation that needs to be presented before the null hypothesis is rejected and the alternative hypothesis is accepted. The significance level for this correlation analysis will be set at 0.025 which is a usual value for two-tailed tests. [1, p 382-397] With this significance level and the number of data points used in the correlation analysis a critical value can be found. This is done by consulting the tables that are available in the statistical literature. The critical value will be a value between -1 and 1, and it forms the boundary that separates the ranges in which either the null or the alternative hypothesis is accepted. When the critical value is 0.35 it means that if the calculated  $r_s$  is between -0.35 and 0.35, the null hypothesis is accepted and the alternative hypothesis is rejected. If the calculated  $r_s$  lies outside of this range, the alternative hypothesis is accepted and the null hypothesis is rejected. This

means that the critical value forms the minimal absolute value that the correlation coefficient needs to be before the correlation is accepted. This critical value will become lower when the number of data points used in the analysis gets lower, as there is less chance of an accidental correlation when the data set becomes very large. [1, p 382-397]

## 6.2. Regression analysis

Using regression analysis a dynamic density model can be created out of the parameters that passed the correlation analysis. The overall process described in this chapter is multiple linear regression, which will be used within this study.

### Regression process

Multiple linear regression is a statistical method that can be used to describe the simultaneous associations of multiple variables with one outcome. [6] These variables are the independent variables that can be selected from the correlation analysis, and the outcome is an estimation of the experienced task load. At the start of the regression phase, there are several parameters that can be used as independent variables. These should all be correlated to the dependent variable, as well as not correlated to each other. The fact that the independent variables are not related makes that there is no multicollinearity, which is one of the often occurring problems in linear regression. [6][16] The other problem that often occurs is the problem of overfitting, which happens when too many independent variables are added without them having a positive influence on the model. Within linear regression the goal is always to create the best-fitting model, while keeping the model itself simple.

$$y_i = \alpha + \sum_{j=1}^P \beta_j x_{i,j} + \epsilon_i \quad (6.4)$$

Linear regression attempts to find a linear relationship between the independent variables and the dependent variables that best fit the input data. The formula used can be found in Equation 6.4 [53, p 17-68]. Within this formula  $y_i$  is the dependent variable at time  $i$ .  $x_{i,j}$  is the  $j^{th}$  independent variable at time  $i$ , while  $P$  is the number of independent variables in the model.  $\beta_j$  is the weight assigned to the  $j^{th}$  independent variable and  $\epsilon_i$  is the error at time  $i$ . The error at a point in time is the difference between the estimated value of the dependent variable and the actual measured value of this dependent variable. This error is therefore the value that needs to be minimized over all data points to get the best fit. It can be minimized by selecting specific values for the weights  $\beta$ . When these weights are found the actual predictive model can be found in Equation 6.5, in which  $Y_i$  is the predicted value of the dependent variable at time  $i$ .

$$Y_i = \alpha + \sum_{j=1}^P \beta_j x_{i,j} \quad (6.5)$$

This method is based on ordinary least squares, so the sum of squares for the data and for the model. The different sum of squares are calculated from the differences between the estimated values, the data values and the mean values for the dependent variable. The total sum of squares (SST) is not dependent on the predicted values and is therefore a constant when keeping the same data set. The SST can be calculated according to Equation 6.6, in which  $y_i$  and  $\bar{y}$  are the data value for point  $i$  and the mean of the data respectively.  $N$  is the number of data points available. The regression sum of squares (SSR) is the sum of squares between the estimated data value and the mean of the data. The error sum of squares (SSE) is the sum of squares between the data value and the estimated value. The equations with which these can be calculated are shown in Equation 6.7 and Equation 6.8 respectively, with the estimated value denoted by  $\hat{y}_i$ . [53, p 33] The SST is a constant value and can be split into the SSR and SSE. When there are no feature variables present in the model the estimated value is equal to the mean of the data set. This means that with an empty model SSE equals SST. When feature variables are added to the model SSR will become a larger part of SST, while SSE will become a smaller part of SST. SSR will not decrease when a variable is added, it will either stay the same or increase. The higher the proportion of SST allocated to SSR, the better is the fit of the regression model with the data set. This is therefore the goal of the regression, while keeping overfitting in mind. [6, p 168-172].

$$SST = \sum_i^N (y_i - \bar{y})^2 \quad (6.6)$$

$$SSR = \sum_i^N (\hat{y}_i - \bar{y})^2 \quad (6.7)$$

$$SSE = \sum_i^N (y_i - \hat{y})^2 \quad (6.8)$$

### Interactive model building

The fitting of the regression equation with the data is almost always calculated by machine. This makes the most interesting part of the regression analysis the decision on which parameters will end up in this regression equation. A computer program can add any variable it receives to a regression model, even if it does have any relation with the dependent variable, so the process of choosing the correct independent variables is very important. After the correlation analysis there are only independent variables left that are not related to each other and that are related to the dependent variable. However, this does not mean that the best model will have all these variables in it.

To decide what independent variables are used in the model, interactive model building should be performed. There are four often-used variations within interactive model building that are discussed below.

#### Forward selection

Within forward selection the initial model is an empty model without any independent feature variables in it. The feature variables are added one by one, in the order of their usefulness. This means that the variables that reduce the model error, which is the sum of all  $\epsilon_i$  as denoted in Equation 6.4, most significantly will be added to the model. There is however a stopping rule implemented on the feature variables that could enter the model. This stopping rule consists of a minimum statistical significance as well as a minimum model error reduction. This is implemented to avoid overfitting the model. When a variable has entered the model, it will not be removed from it. So the forward selection process stops when all variables are in the model, or when no variables outside of the model pass the stopping rule. [6]

The fact that once added a variable will stay in the model does create some flaws in the forward selection process. The process is not very flexible, and it will not always find the optimal model. This is because the different feature variables interact with each other in the model. When a variable is added to the model it explains part of the change in model error. It can however happen that a different feature variable explains a similar part of the change. It can therefore happen that a variable is added first in forward selection because it creates a large change in model error, but several other variables that are added after also explain parts of this specific change in error. The contribution of the first variable to the error reduction will therefore change with the addition of more variables. It might happen that this first variable even ends up below the stopping rule, but since variables cannot be excluded after entering the model this now less useful feature variable is still part of the model. [6]

#### Backwards elimination

Backwards elimination follows a very similar approach to forward selection, however, it works in the opposite direction. The initial model contains all feature variables, and instead of adding variables to the model they will be removed. The variable that will be removed first is the variable that contributes very little to the model error, meaning that it can be removed without a drastic change in model error. It will be selected on the fact that it reduces the model error the least. Similar to the forward selection procedure there is again a stopping rule. This time it determines if a variable is allowed to exit the model. Once a variable has exited the model it may not enter again. [6]

The flaws of this procedure are also similar to forward selection. It can happen that a variable is removed from the model, while it could have been of value at a later stage due to the fact that other feature variables exited the model.

### Step-wise Regression

Step-wise regression is a combination of forward selection and backwards elimination. There is an entry threshold just like in forward selection, as well as an exit threshold just like backwards elimination. The initial model is an empty model. Within this procedure first a variable is added to the model when possible, after this the model is evaluated to see if a variable can exit. Then the model is evaluated again and a variable can be added. This loop will continue until there are no variables in the model that can overcome the exit threshold, and there are no variables outside of the model that can overcome the entry threshold. It is not necessary for a variable to enter and exit at every step in the process. This procedure has the advantage that variables can enter and exit when the thresholds are met, which makes the method more flexible.

### Best subsets regression

The best subsets regression is not an iterative regression method like the previous three, instead it is a brute force method. Just like the others, this method starts with a set of feature variables that can be used inside the model. It then performs a regression analysis of every single combination of variables. This can be a combination of excluded and included variables, so the number of feature variables included will vary between the different options explored. This method explores every single possible model created from the available feature variables, so it can be very computationally heavy. A set of 9 available feature variables would generate 512 different models, as the number of models is related to the number of feature variables via  $2^p$ , with  $p$  being the number of feature variables. From the different model options the best one can be selected based on several parameters, of which Mallows  $C_p$  and  $R^2$  are most often used. Both of these parameters are explained in the next section.

### Model measures

When comparing different models it is important to use the proper measures. Some of these have been discussed in the previous sections, but this section shows two more commonly used parameters in the coefficients of determination and Mallows's  $C_p$ .

#### Coefficient of determination

Two important model measures are the measures of coefficient of determination ( $R^2$ ) and the adjusted coefficient of determination ( $R_a^2$ ). The coefficient of determination is a measure of the change of the dependent variables that is explained by the current independent variables. In terms of SSR and SST,  $R^2$  is given by the fraction of SSR over SST. [6, p 168-172]. This is a useful measure when comparing different models, but it does have a clear disadvantage in the fact that adding a feature variable will always create a higher  $R^2$ . To counteract this problem,  $R_a^2$  is used. This measure is based on  $R^2$ , but also takes the ratio between the number of observations and the number of feature variables in the model into account. The value for  $R_a^2$  can be found in Equation 6.9, in which  $n$  is the number of observations and  $p$  is the number of feature variables in the model.

$$R_a^2 = 1 - (1 - R^2) \frac{n - 1}{n - p - 1} \quad (6.9)$$

This measure can increase and decrease with the addition of feature variables in the model. This depends on the ratio between these feature variables and the number of observations. When a model has many feature variables and few observations, the value of  $R_a^2$  will become low. When it is the other way around and there are many observations of few feature variables, the value of  $r_a^2$  will increase.

#### Mallows's $C_p$

Mallows's  $C_p$ , from here referred to as  $C_p$ , is a measure for evaluating and comparing models. It evaluates the fit of a model on which regression has been performed based on ordinary least squares. This specific metric is almost exclusively used in model selection. [29][50] It can be used on all models that are a subset of the set of available feature variables, it can not be used to evaluate the model in which all of these variables are present. For the full model the value of  $C_p$  will always be one more than the number of feature variables in the model. It can be calculated using Equation 6.10. In this equation  $SSE_p$  is the error sum of squares for the model with all  $p$  feature variables active in the model.  $MSE_k$  is the mean squared error of the model with  $k$  active feature variables, where  $k$  is a subset of  $p$ .

$$C_p = \frac{SSE_p}{MSE_k} + 2(p + 1) - n \quad (6.10)$$

The goal for a model with respect to Mallows's  $C_p$  is to have a  $C_p$  value that approaches the number of feature variables in the model, plus one. So when there are two feature variables in the model the preferred value for  $C_p$  is 3. When the values for different models are comparable, the simplest model will be preferred.

## Research Plan

This chapter discusses the research plan of this study. First, the research objective and question are shown, after which the different work packages that are part of this research are discussed. Within this discussion, the choices made in setting up this research will be explained.

### 7.1. Project Objective & Research Questions

The work and task load of air traffic controllers are related to the airspace capacity. This has been researched for air traffic controllers working in Area Control, while little to no research has been done for the other facets of air traffic management. At Schiphol Airport the airport capacity is influenced by the task load of the ground controllers. An experiment based on ground controller expert judgment determined that one of the causes for a high task load within ground control at Schiphol Airport could be the utilization of the third ground controller. At Schiphol airport there is the possibility to control the ground traffic with three controllers, however often two controllers are used in situations where it might have been useful to use three ground controllers.

Since no research has been done in creating a quantitative data-driven way to estimate the ground control task load at Schiphol Airport, proposed mitigations for the above-mentioned situations cannot be tested to see if they would affect the task load experienced. From this gap, the following research objective was constructed.

**To analyze the effect the utilization of the third ground controller has on the experienced ground controller task load in Schiphol Tower Center, by modeling controller task load using a dynamic density model.**

This objective plays upon two different research gaps. The first one is that it provides a way to estimate ground control task load at Schiphol Airport for which no objective data-driven method has yet been fully created. Secondly, it fills a gap within the area of dynamic density. This methodology has previously been used to estimate controller task load within the Area Control division of ATC. However, this approach has never been translated to ground control, a part of ATC that is vastly different from area control. With this objective, the study will apply the dynamic density methodology on ground control at Schiphol Airport, which therefore also fills a gap within the dynamic density research area. From the above-stated objective, the following research question has been created.

**What is the effect the utilization of the third ground controller has on the experienced ground controller task load in Schiphol Tower Center, and can it be analyzed by estimating the controller task load using a dynamic density model?**

This research question has the following associated sub-questions:

1. Can a dynamic density model be created to estimate ground controller task load?
  - (a) What independent feature variables are needed within this dynamic density model?

- (b) How can these potential variables be tested on correlation with the dependent variable of task load?
  - (c) How can the correct weights of the independent variables within the dynamic density model be found?
  - (d) What type of data can be used as task load data?
2. How does the utilization of the third ground controller influence the experienced task load of all active controllers?
- (a) What are the current practices regarding the use of the number of ground controllers?
  - (b) What scenarios are suitable for estimating the task load change due to a change in the utilization of the third ground controller?
  - (c) How can the effect of utilization of the third ground controller on the dynamic density parameters be simulated?

## 7.2. Project Planning

This section will discuss the four main research work packages of this research, which are the Literature Review and Project Scoping, the Data Analysis, the Experiments, and the Result Analysis.

### Literature Review and Project Scoping

The Literature Review and Project Scoping phase of the research is the first phase of the report and has this report as its deliverable. The goal of the project scoping should lead to a research objective and question, which can be found in the previous section. The literature review is done to generate an overview of all needed literature and information regarding the research. In this case, the research objective can be split into a what, a where, and a how.

The what resembles the parameter that is researched in this project, which is the task load of the controllers in the three central ground control sectors at Schiphol Airport. Within the literature study, this task load is found to be related to the air traffic complexity as well as to several RT parameters. Both of these correlations are needed to link the task load to the dynamic density model, which is a necessity for answering the research question. The where of this research is ground control at Schiphol Airport. The task load that will be estimated in the research is the task load of the ground controllers working at Schiphol Airport. For this reason, ground control, as well as Schiphol Airport, are both analyzed within the literature review. So the task load of ground controllers at Schiphol Airport will be analyzed, which will be done using a dynamic density model. This dynamic density model is the how of this project. A dynamic density type model has been chosen because it is an objective data-driven method, that can be created in a way in which it only depends on measurable traffic parameters. This was needed as there will be no opportunity to include taking measurements from active controllers at Schiphol Airport. Dynamic density has also been proven in the somewhat similar field of Area Control, and it can be endlessly adjusted to fit the needed problem. The first step for creating a dynamic density model is to find a variety of independent variables that have a relation with the variable that should be estimated. This means that a list of parameters is needed that will potentially have a relation with the controller task load. This list of parameters is one of the important results of this literature review and is extensively discussed within this report.

### Data Analyse

The data analysis phase consists of the creation of the dynamic density model. This model will have several different traffic parameters as an input, while having an estimation of the task load at that moment as an output. The model that will be created can either be used on historical data, live data, or predicted future data. Since the only input is traffic data, it can be used at every moment in which the traffic flows are known. If the model will be used on a moment in the past, the traffic flows have already taken place and can thus be used as input. When using the model on a live traffic situation, the input can be linked to the traffic systems used to log all traffic data. When wanting to use this model in a predictive way, it is needed to have a prediction of the traffic flows at that moment. This can be done by linking the model to a taxi planning algorithm, through which it will be able to calculate the

predicted task load within the predicted scenarios. The fact that this model can be used for the past, present and future makes it a potentially powerful tool for controller task load estimation. There is no difference in how the model works for these three cases, in all of them the only input is the traffic parameters. So the difference lies with how the traffic parameters are collected. Within this research, as will become clear in the section regarding the experiment, the model is used on historical data and therefore not on live or predicted traffic.

The data analysis phase of the research is the phase that comes directly after the literature study. The list of potential parameters that are related to the task load is one of the inputs for this data analysis. These parameters have been established within this literature review report. The other inputs to this phase are the different types of data used, of which the most important ones are the R/T data and the ground radar data. The goal of this phase is to create a dynamic density model that can estimate the task load experienced within ground control at Schiphol Airport during a specific scenario.

This phase starts with creating a script that can calculate the potential parameters found in the literature review, from the available data sources. The data source from which almost all parameters will be calculated is the ground radar data. This is data that specifies the location of the different aircraft in the maneuvering area over time. The update frequency is a second, so for every combination of a time and aircraft, the location, speed, heading, and flight identification number are known. When the parameters can be calculated, a correlation analysis will be performed. This analysis tests the correlation of these potential independent variables with the task load data, for which RT data will be used. After this, the correlation between the different potential independent variables themselves will be calculated. The RT data used consists of all calls that have been made on the four different RT frequencies at Schiphol Airport. For every call the starting time, the call duration and the frequency are known. From this, the RT Occurrence and the Total RT time can be calculated, which are related to the task load. These two parameters are therefore used in the correlation analysis. After this analysis, a list of independent variables that can be part of the model is created. It is important that the variables on this list are correlated with the task load, but also that no two variables on this list are heavily correlated with each other. This is important when forming an efficient dynamic density model. The last part of this phase is to perform a regression analysis on the parameters that passed the correlation analysis. The result of this regression analysis is the dynamic density formula. For a regression analysis task load data is needed, for which again the RT Occurrence and the Total RT Time are used. The completed dynamic density formula can be combined with the script made to calculate the independent variables, the result will be a model that uses the data sources as input and gives the estimated task load as output. The last two steps within this phase are the verification and the validation of the code. The verification can be done as soon as the coding process has started, while validation will mostly be done when the overall code is finished.

### Experiment

The experiment phase starts with the previously established dynamic density model as its input. The main question and objective of the research have been to analyze whether or not the effect of a change in the utilization of the third ground controller can be estimated using this dynamic density model. The experiments should answer this question. For this, it is best to elaborate on the utilization of the third ground controller, something that was researched and discussed in the literature research. From the main air traffic tower at Schiphol Airport, three different ground sectors are being controlled by the ground controllers. These three different sectors are controlled by one to three controllers. Most of the time there will be one controller active for the North sector, and one controller active for the South sector. The Center sector is then controlled by one of these two controllers. There are moments in which the Center sector will be controlled by a third controller. The utilization of this third controller is determined by the used protocols. This mostly happens when the center runway is actively used, or on some occasions when the traffic load demands it.

When talking about the effect of the change in utilization of the third ground controller within the research question, the focus lies on this second scenario. It is more interesting to see what the effect is of the incorporation of the third ground controller, at a moment in time where otherwise two ground controllers were used. How does this incorporation affect the task load of all three controllers? When the answer to that question is known, the research question itself can be answered.

To test this there should be scenarios available in which the third ground controller was not active, while the North and South controller were experiencing high task loads. Similarly, scenarios in which the third ground controller was active without actively using the center runway can be used. These traffic scenarios can then be used to calculate the task load in two different situations. One time with three controllers controlling the three sectors, and one time with only two controllers controlling these sectors. The task load for all controllers in these situations will be calculated and brought along to the results analysis.

The scenarios that are needed will be found within the historical radar data available. All types of scenarios will be found, which will include scenarios in the outbound peak, inbound peak, and between the two peaks. There will also be scenarios included in which the inbound and outbound peak overlap. The focus will lay on the 5 most used runway configurations, and extra attention will be paid to scenarios in which the configuration changes during the scenario. This way the scenarios will be very diverse. However, for every sup-group of scenarios there will multiple different scenarios used, so that they can be compared to other scenarios with a similar situation.

### Result Analysis

The results of the above-discussed experiment are an estimated task load over time for all different scenarios. These results will first of all be used to answer part of the research question, which is whether or not the dynamic density model was able to make a logical task load estimation. Then the remaining part of the research question is to see what the effect of the utilization of the third ground controller is on the experienced ground controller task load in Schiphol Tower Center. For this, it will be needed to first analyze all scenarios and see if there is an overlying trend in the data. How does, on average over all scenarios, the controller task load react to the addition or reduction of the third ground controller in a scenario? When this is researched, the same thing will be analyzed for the different sub-groups within the scenarios. So the inbound and outbound peak scenarios are analyzed separately, as is done with the other groups. With this sub-group analysis, the influence of certain outside factors can be analyzed. It might for example be found that adding a third ground controller has a large influence on the task load of all controllers within the inbound peak, but not in the outbound peak. When that is the case, it should be analyzed what the reason for this is. This will all be analyzed within the result analysis.

After the result analysis a sensitivity analysis will be performed. This is to be done to see what the influence of small adjustments in the model or in the input data is for the end results. This will give a certain level of validity to the results.

## Conclusion

The previous chapters form a literature study that was conducted on the use of dynamic density as a task load indicator within ground control at Schiphol Airport. This chapter will summarize the most important conclusions that were drawn from the literature.

### Ground Control at Schiphol Airport

A ground controller at Schiphol Airport controls the traffic when it travels between the gates and one of the six runways, or vice versa. The three goals of a ground controller are ensuring safety, sequencing and streaming. Ensuring safety simply means that the aircraft should always have a safe separation distance between them. The goal of streaming is to keep the aircraft moving as much as possible. This is a goal because moving aircraft can be moved more flexibly than aircraft that are standing still. Sequencing means that the ground controller delivers the outbound traffic to the runway in a specific sequence. This sequence is dependent on the Standard Instrument Departure of the aircraft, as well as its wake-turbulence category. An optimal sequence will increase the runway capacity of the departure runway.

Within Schiphol Airport there is always a minimum of one and a maximum of four ground controllers active. All these controllers have their own ground sector to control.

### Task Load

Mental workload is often said to be a combination of the specific task load that has been generated by the to-be-performed task, as well as specific characteristics of the performer of this task. This research focuses on the task load. Within air traffic control this task load is heavily related to air traffic complexity. [55] [8] This air traffic complexity is formed by the traffic flow moving through the sectors and is only dependent on traffic characteristics. This means that the task load can be estimated when estimating the air traffic complexity using different traffic parameters, which is what this research aims to do.

Air traffic control task load is also researched to be correlated with specific radio telephony parameters. [12][54][61] Radio telephony is the communication method used with which the controllers communicate with the pilots. It is a two-way frequency, of which the number and duration of the calls are logged. The parameters there were found to be correlated with the task load data are the R/T Occurrence and the Total R/T time, which are the number of calls in an interval as well as the percentage of time in an interval in which the frequency was active.

### Dynamic Density

Dynamic density is used to describe the process in which task load is estimated by a summation of differently weighted air traffic parameters. This dynamic density is linked with task load via the air traffic complexity that it estimates. To create a dynamic density model, independent variables are needed that might have a relation with the dependent variable, which is task load in this study. In the dynamic density research, the majority of the useful previous research came from a joint dynamic

Table 8.1: Suggested dynamic density parameters

#	Parameter	Description	Source
P1	Aircraft Density	#Aircraft divided by the size of the sector	Kopardekar (2000)
P2	Aircraft Count	#Aircraft present in a sector	Wyndemere (1996)
P3	Aircraft near boundary	#Aircraft that are moving near the sector boundary	Chatterji (1997)
P4	Number of handovers out	#Aircraft handed over to neighbouring sectors	Chatterji (1997)
P5	Number of handovers in	#Aircraft received from neighbouring sectors	Chatterji (1997)
P6	Aircraft distribution	Spread of aircraft over the sector	Shridhar (1998)
P7	Direction variance	The differences in taxi direction for the aircraft	Wyndemere (1996)
P8	Configuration switch	Did the runway configuration switch	Koros (2003)
P9	Controller switch	Did the number of active sectors switch	Experiment
P10	Number of pushbacks	#Pushbacks performed in the interval in the sector	Experiment
P11	Number of landings	#Landings performed in the interval in the sector	Experiment
P12	Bay traffic count	The average number of aircraft in the bays	Experiment
P13	Stationary aircraft	The time in which aircraft are standing still	Experiment

density research that was started by three research institutions. These were the FAA William J. Hughes Technical Center, the NASA Ames Research Center and Metron Aviation. From these researches, as well as some others, a number of useful parameters were found. Some of these parameters were translated to ground control, together with some parameters found in the earlier mentioned experiment. These parameters can be seen in Table 8.1.

To create a dynamic density model from these parameters a regression analysis must be performed. This analysis starts with a number of potential parameters that are all analysed for a correlation with the task load. All parameters that are not correlated with the task load cannot be used in the model. The remaining parameters are tested to see if they have a correlation with one of the other parameters. This is done as it is not efficient to have two parameters inside a dynamic density model that are correlated with each other. When two parameters are heavily correlated, one of them is dropped. The correlation technique that is best suited for the data in this study is Spearman's Rank Coefficient, since it can deal well with outliers and is not too computationally heavy.

The remaining parameters are the starting point of the model building. There are four ways of model building explored in this study. Forward selection, backwards elimination and step-wise regression are all iterative model building methods, while best subsets regression is a brute force model building technique that can be used when the number of potential parameters is not too large. These model building techniques are based on multiple linear regression and will all result in a dynamic density model that will be able to estimate the task load of the ground controllers at Schiphol Airport. The best model will be chosen using different model measurement parameters, for which the goal is to choose the model that estimates the task load best, while not overfitting the model with too many independent variables.

# III

Supporting work



# Ground Control at Schiphol Airport

This chapter expands on the Ground Control section presented in the preliminary report, providing new insights and in-depth analysis. It covers various essential aspects of ground control operations at Schiphol Airport, including the roles, responsibilities, and objectives of ground controllers. The chapter also delves into the work environment of ground controllers, discussing the equipment they use and the communication systems they rely on. Additionally, it examines the division of ground control sectors at Schiphol Airport and presents findings from a task load experiment, shedding light on factors influencing controller workload. These insights contribute to our understanding of ground control operations and offer valuable considerations for improving operational efficiency and safety at the airport. The experiment conducted with ground control operational experts during this research is discussed at the end of this chapter.

## 1.1. Controller responsibilities and goals

A ground controller is the air traffic controller that an aircraft will communicate with between Apron Planning & Control (APC) and Schiphol Tower Control (TWR), meaning an aircraft will communicate with ground control between pushback and entering the runway for outbound flights, and between exiting the runway and parking for inbound flights. The ground controllers will be responsible for all aircraft that are within these points in time, which is called the taxi phase, and that are inside the manoeuvring areas. Movements on and onto an active runway are excluded for this. [19, p.319][41] On Schiphol Airport the official responsibilities of the ground controller are to provide Aerodrome Control Service, Alerting Service and Flight Information Services to aircraft, towing traffic and other vehicles moving inside the manoeuvring area. [49][41] While the towing traffic is the responsibility of the ground controller, it is being controlled by APC. These two Air Traffic Control (ATC) divisions are currently located in different locations in the tower. However, the process of placing tow control next to ground control at the same location has already started. This is done to create a higher shared situational awareness. [44]

The tasks assigned to a ground controller working for LVNL, as outlined in the Ground Control Manual [41], encompass a range of critical responsibilities. These tasks include:

- Maintaining communication with all flights within the controller's jurisdiction.
- Providing pushback and taxi instructions to departing aircraft.
- Handing off departing aircraft to the runway controller and facilitating the transfer of aircraft crossing an active runway.
- Issuing instructions to prevent collisions and unauthorized runway entry.
- Facilitating the transfer of aircraft to another controller as they leave the controller's sector.
- Informing aircraft about weather conditions and the status of navigational equipment.

- Assigning remote holding places for aircraft.
- Operating taxiway lighting systems.
- Raising alarms and coordinating emergency procedures in case of emergencies.

These tasks collectively ensure the safe and efficient movement of aircraft within the ground control domain, while also maintaining effective communication and upholding safety protocols.

The procedural sequence followed by aircraft at Schiphol Airport after start-up involves several stages. Once start-up clearance is granted by the Outbound Planning (OPL), the corresponding flight strip for that aircraft appears on the ground controller's flight strip screen. The pilot must await completion of all necessary checks and confirmation that the aircraft is prepared for pushback. When the aircraft is ready for pushback, the pilot communicates this information through the assigned sector frequency. The ground controller then either authorizes the pushback or instructs the aircraft to hold until further notice. Often a controller will, when possible, perform a visual check by looking at the aircraft through the tower window to see if pushback clearance is indeed requested when all safety checks are done. This is done as sometimes airlines will request pushback too soon to get an earlier take-off. Subsequently, the pilot contacts the pushback driver after receiving pushback clearance. In the event that pushback does not commence within one minute of receiving permission, the pilot must request permission again by contacting the controller [42].

Once cleared for pushback, the aircraft receives additional instructions. These instructions may involve holding after pushback, waiting for a specific aircraft to pass safely, or commencing taxiing. The controller provides the designated route to the aircraft before taxiing. Typically, the routes utilized align with the standard taxi routes established at Schiphol Airport, although alternative routes may be assigned on occasion. While efforts are made to minimize communication between the pilot and controller during taxiing, additional communication may become necessary. This can occur when an aircraft has priority over another aircraft in a manner that deviates from standard priority rules or when a situation arises within the manoeuvring area. Upon reaching the runway entry point, the controller notifies the aircraft to switch to the tower frequency, effectively concluding their communication. This procedural outline applies to outbound flights. For inbound flights, the process remains similar, with initial contact occurring upon runway exit and final contact transpiring during parking operations.

According to various ground controllers who worked for Air Traffic Control the Netherlands, the three main goals of a ground controller are ensuring safety, sequencing and streaming, which are discussed below.

### Ensuring Safety

The goal of ensuring safety is the most important goal at all times at Schiphol Airport. To achieve this, ground controllers are responsible for ensuring adequate separation between aircraft on the ground, both during taxiing and on the aprons. Maintaining this separation is crucial to prevent potential hazards and mitigate the risk of collisions. Additionally, to optimize sequencing and achieve smooth traffic flow, it is essential to proactively identify and resolve conflicts before they significantly impact the movement of aircraft. By anticipating and resolving conflicts in advance, disruptions to the traffic flow caused by sudden changes in aircraft behaviour can be minimized. Hence, continuous monitoring is an essential task for ground controllers, who must remain vigilant to detect potential conflicts within their assigned area of responsibility.

### Sequencing

Achieving an optimal sequence of outbound traffic is essential to maximize runway utilization and overall runway capacity at Schiphol Airport. The ground controller plays a key role in delivering the traffic to the runway controller in the most favourable order. The sequence provided by the ground controller significantly affects the average waiting time for each aircraft before it can take off following the preceding aircraft. Several factors influence this process, including the specific Standard Instrument Departure (SID) in conjunction with the runway configuration, the wake turbulence categories of the

aircraft, and the utilization of intersections. [41]

SIDs refer to departure routes designed for all IFR-traffic departing from Schiphol Airport. Each take-off runway has multiple SIDs that are designed to optimize airspace utilization while minimizing noise impact on densely populated areas. The connection between SIDs and sequencing arises from the fact that the SIDs assigned to two consecutive departing aircraft determine the time interval required between their departures. If two aircraft with the same SID and similar speeds depart consecutively from the same runway, a longer waiting time is necessary for the second aircraft compared to a scenario where the second aircraft has a different SID. Therefore, it is advantageous for the ground controller to adjust the sequence of aircraft based on their SIDs to avoid consecutive departures with the same SID.

Furthermore, the order in which aircraft of different wake turbulence categories take off can influence runway capacity at Schiphol Airport. Thus, the sequencing decisions made by the ground controller directly impact runway capacity, taking into account both the wake turbulence category and the assigned SID of each aircraft. Additionally, during sequence creation, the ground controller has the flexibility to assign aircraft to start at specific intersections instead of at the beginning of the runway. However, intersection departures are only employed when operationally necessary. For instance, if a series of aircraft with similar SIDs or unfavourable wake turbulence categories are waiting in succession at the start of the runway, the ground controller may choose to utilize an intersection departure to insert an aircraft between them, thereby improving the overall sequence. [41]

By considering these factors and making informed sequencing decisions, the ground controller contributes to optimizing runway capacity, minimizing delays, and ensuring an efficient and safe departure process for aircraft at Schiphol Airport.

### Streaming

The concept of streaming in ground control operations aims to facilitate the continuous movement of aircraft through the manoeuvring area with minimal delays. The primary objective of effective streaming is to ensure that all traffic can progress smoothly and efficiently. In pursuit of this goal, priority is given to moving aircraft over stationary aircraft, even if the moving aircraft deviate slightly from the most optimal route. This preference comes from the inherent flexibility of a moving aircraft compared to a stationary one.

When aircraft remain stationary for an extended period, especially larger aircraft, it takes longer for them to resume motion once they start moving again. Therefore, for optimal streaming, it is advantageous to keep heavy aircraft in motion and halt smaller aircraft when necessary, as the smaller aircraft can resume movement more quickly after being stopped. By prioritizing the continuous flow of larger aircraft, potential delays and disruptions in the traffic stream can be minimized.

## 1.2. Sectors

Amsterdam Schiphol Airport employs ground controllers who operate from two distinct control towers. During peak occupancy, three ground controllers are assigned to Schiphol Tower Center, while one ground controller operates from Schiphol Tower West. Ground traffic management at Schiphol Airport is organized into different geographical regions, with each region overseen by one to four controllers. Collectively, these controllers are responsible for managing four sectors: North, West, South, and Centre.

Among these sectors, the North sector is the largest, encompassing three runways: 04/22, 09/27 and 18L/36R. The South sector contains runway 06/24, while the Centre sector is responsible for 18C/36C. Lastly, the West sector is associated with the more remote 18R/36L. This division of sectors and runways ensures effective management of ground traffic at the airport. [49, p.13][41]

It is worth noting that the ground controller assigned to the West sector is always positioned at TWR-W. This arrangement is necessary because runway 18R/36L is situated at a considerable distance from the main area of Schiphol, making it difficult to observe from TWR-C. Thus, by stationing the West sector controller at TWR-W, optimal visual coverage and oversight of operations on runway 18R/36L

are ensured. The visual representation of the ground control sectors and their associated runways is depicted in Figure 2.1, providing an overview of the sector allocation and the spatial layout of Schiphol Airport's ground control operations.

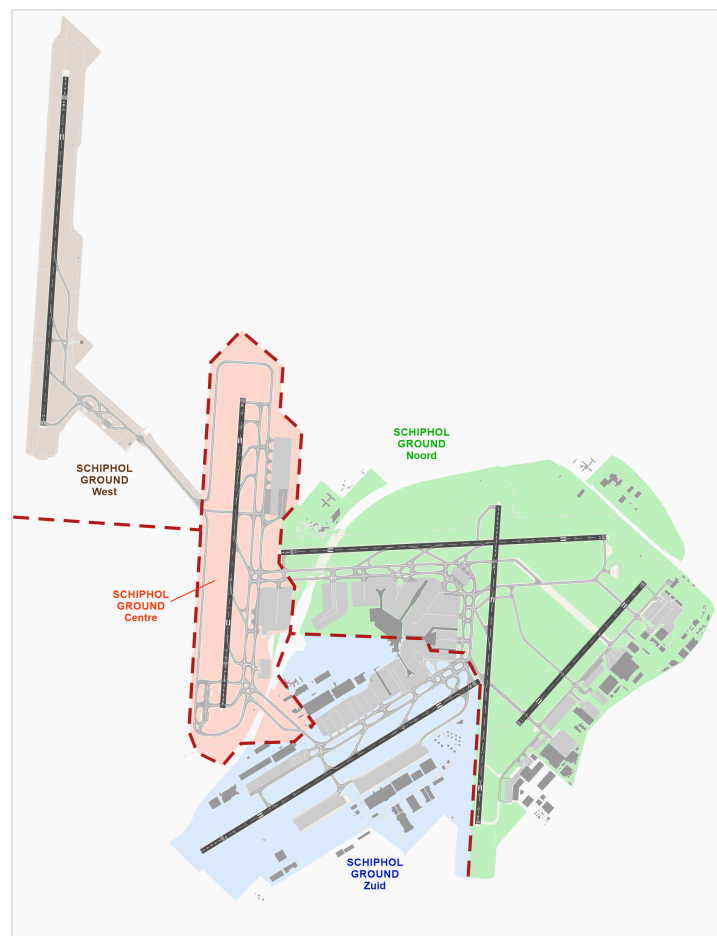

Figure 1.1: Ground Control Sectors [41]

The layout of the ground control sectors at Schiphol Airport remains consistent, with only two areas that have the flexibility to be transferred between sectors during operations. These transfers are carried out after coordination among all controllers.

The first area is taxiway Quebec, situated at the southeast end of the Centre sector. Under normal circumstances, it falls within the Centre sector. However, if traffic demands require it, this area can be temporarily transferred to the South sector. Similarly, the D-pier, the pier shaped like a tuning fork located on the northern border between the South and North sectors, is typically part of the North sector. Nevertheless, it can be temporarily transferred to the South sector based on operational needs.

These temporary transfers of specific areas can be performed by the ground controllers themselves, under the supervision of their supervisor, within the control tower. It is important to note that these adjustments are not logged, as they are small-scale and temporary alterations made to accommodate the dynamic traffic conditions and optimize sector workload distribution.

### 1.3. Controller workplace

Within this section, the workplace of the controller is discussed. This means the physical place and all the equipment used by a controller, as well as the communication lines a controller uses during the job.

Next to this the transferring of shifts between different ground controllers is discussed in this section.

### Tower entities

Within the tower, there are a lot of controlling entities besides the ground controllers. Together they control everything in the manoeuvring area, as well as the Schiphol Control Zone (CTR). All roles within the TWR-C that have a link with the ground controllers will be discussed.

#### Tower Supervisor (SUP)

The Tower Supervisor (SUP) plays a crucial role in the overall tower process at Schiphol Airport, assuming responsibility for delivering all ATC services within the manoeuvring area and the CTR surrounding the airport. The primary objective of the SUP is to ensure the provision of high-quality ATC services. Several key tasks are assigned to the SUP:

Firstly, the SUP is responsible for monitoring all personnel involved in the tower operations, including the ground controller. As the overall authority overseeing the tower process, it is essential for the SUP to stay informed about the status of operations. This entails monitoring the activities of other individuals and actively coordinating with them. Secondly, the SUP holds ultimate responsibility for making significant decisions regarding the tower process. This includes responding to weather forecasts and formulating strategies for emergency situations. These critical decisions are within the purview of the SUP.

Another important responsibility of the SUP is determining the runway configuration to be used. However, this task is not solely the responsibility of the SUP. The decision on runway configuration is made in coordination with the Approach Supervisor and the Flow Manager Aircraft. The Approach Supervisor, similar to the SUP, carries out corresponding responsibilities within the Approach Control unit. The Flow Manager Aircraft is accountable for managing various aspects of aircraft operational flows on the airside.

The communication between the ground controller and the SUP occurs through face-to-face interaction since both are located on the 12th floor of TWR-C. Although communication between them happens frequently, it is not considered one of the most heavily utilized communication channels for the ground controller. The SUP is active during the day, and during the night, a standby SUP is available to be deployed as required.

#### Runway Controller (RC)

The Runway Controllers at Schiphol Airport are responsible for providing Air Traffic Control services in the vicinity of the landing area, which specifically includes the runways and their exits. They play a crucial role in the ATC chain, positioned between Ground Control and Approach Control. When an aircraft is in line for takeoff at one of the runway entries, it is handed over from the Ground Controller to the Runway Controller. Similarly, the runway controller will hand over an aircraft to the ground controller as soon as it leaves the runway after landing.

The Runway Controllers have various important tasks, with the primary focus on preventing collisions between aircraft while ensuring the safe and efficient flow of inbound and outbound traffic. Their responsibilities primarily encompass aircraft in the landing or takeoff phase. Additionally, similar to Ground Controllers, Runway Controllers provide Flight Information Services and Alerting Services. They are responsible for granting permission to cross active runways, a request that can be made by Ground Controllers or the Second Tower Assistant. [52]

In terms of communication, Runway Controllers have two frequently used communication lines, one with Ground Control and the other with Approach Control. However, for the purposes of this research, the communication line with Ground Control is more relevant. This communication takes place face-to-face since both Ground Controllers and Runway Controllers are located on the 12th floor of TWR-C. Typically, this communication involves requests to cross the runway, although additional communication may be necessary in situations such as abnormal conditions on taxiways or when certain runway exits are no longer preferred.

### **Outbound Planning (OPL)**

The Outbound Planning plays a crucial role within the tower process at Schiphol Airport. Their main responsibility is to create an optimal departure plan for all outbound traffic, which significantly impacts the flow of outbound aircraft and, consequently, the work of the ground controllers. The OPL determines the specific times at which aircraft should be ready for start-up, as they will hand over the aircraft to the ground controllers at these designated points. Given that the majority of outbound traffic requests start-up during the outbound peak period, the outbound planner plays a vital role in distributing these start-up requests throughout the peak period. This distribution of start-up requests is crucial in managing the flow of outbound traffic effectively. [52]

The Outbound Planner, similar to the ground controllers, is located on the 12th floor of TWR-C. Communication between the outbound planner and the ground controllers takes place face-to-face, and it is considered one of the more intensively used communication links for the ground controllers. However, it is important to note that the communication primarily occurs with the ground controllers who are responsible for the North or South sector, as these are the sectors from which the outbound planning originates.

### **Tower Assistant 2 (TWR ASS-2)**

The Tower Assistant 2 (TWR ASS-2) is another important actor located on the 12th floor of TWR-C at Schiphol Airport. The TWR ASS-2 has a supportive role, primarily assisting the ground and runway controller in their tasks. Additionally, the TWR ASS-2 serves as a communication intermediary between the runway controller, ground controller, and various entities across the airport. These entities include the controllers in TWR-W, vehicle drivers in the manoeuvring area, and airport services or emergency personnel. The TWR ASS-2 acts as a liaison, relaying information and instructions between these parties.

Moreover, the TWR ASS-2 has the ability to control vehicles in the manoeuvring area, but this is done under the responsibility of the ground controllers. The TWR ASS-2's involvement in vehicle control is coordinated with and supervised by the ground controllers. [52] The communication between the TWR ASS-2 and the ground controller is frequent and intensive, and it occurs face-to-face. The nature of this communication often involves the TWR ASS-2 informing either the ground controller or the runway controller about their actions or tasks that need to be performed.

### **Apron Planning & Control (APC)**

The Apron Planning & Control (APC) has an important role at Amsterdam Schiphol Airport that falls under the responsibility of the airport itself, rather than LVNL. Unlike the other roles discussed earlier, the APC is located on the 10th floor of TWR-C, which is different from the 12th floor where the other roles are situated. As a result, the communication between the APC and the ground controller is done via line communication rather than face-to-face interaction.[52]

The APC has two main areas of responsibility: Apron Control and Planning. For the purpose of ground control and this research, the Apron responsibilities are most relevant. The APC has to ensure the efficient and safe handling of towing traffic within the airport. Towing traffic involves smaller vehicles that are responsible for moving aircraft from one location to another without taxiing. While the ultimate responsibility for all moving entities in the manoeuvring area lies with the ground controllers, the APC specifically handles the towing traffic. This creates a need for shared communication between the APC and the ground controller. In certain situations, the APC may need to request permission from the ground controller to cross specific areas of the manoeuvring area with the towing traffic. Therefore, the communication line between the APC and the ground controller is regularly used, and it is often initiated from the APC's side.

### **Communication reduction**

In the previous sections, we discussed the various roles connected to ground control operations at Amsterdam Schiphol Airport. These roles have direct communication links with ground controllers. However, it is important to note that even the most frequently used communication links are not actively utilized very often. This is primarily due to the increased automation in communication pro-

cesses. In the past, when TWR-C still relied on paper flight strips, every aircraft had to be physically transferred to the respective controller, resulting in a significant amount of communication. However, with the adoption of electronic flight strips at both TWR-C and TWR-W, the need for this type of communication has been eliminated. Aircraft can now be transferred to another controller without the need for direct communication between controllers.

This shift to electronic flight strips has significantly reduced the communication required between ground controllers themselves, as well as between ground controllers and runway controllers or the outbound planner. As a result, there is no heavily used communication link in operation. The most common communication occurs between ground controllers when issues arise that impact traffic flow in other sectors or when considering rearranging active sectors. In such situations, they need to communicate and collaborate to address the problem effectively.

## Workplace

At Tower Centre, the ground controllers have a direct and unobstructed view of all runways except for the runway 18R/36L, which is located far away. However, they have a clear line of sight to almost all taxiways, apron areas, and gates that are situated to the east of runway 18C/36C. The layout of the working stations for the controllers is strategically designed to provide them with optimal visibility of the sector they are responsible for. This arrangement ensures that controllers can effectively monitor and manage the air and ground traffic within their designated sector. At their workplaces, there are several digital tools that play a crucial role in enhancing situational awareness and overall safety during operations. These tools are presented on multiple screens, providing controllers with important information. One of the screens that significantly contributes to situational awareness is the Airport Surface Detection Equipment (Airport Surface Detection Equipment).

The Airport Surface Detection Equipment is a vital tool displayed on one of the screens at the ground controllers' workplaces. ASDE provides a top-down view of Amsterdam Schiphol Airport, presenting real-time information about the location and movements of active vehicles on the ground. The data used by ASDE is gathered from various primary and secondary radar sources. By observing the ASDE screen, controllers can quickly assess the positions and directions of vehicles in motion, thereby enhancing their situational awareness. This tool is particularly valuable during operations with reduced visibility, as it enables controllers to maintain a clear understanding of ground movements. The ASDE radar has a refresh rate of one second, ensuring that the displayed information is relatively up-to-date. Additionally, the radar screen also includes a visual representation of the Tower radar, allowing ground controllers to monitor approaching airborne flights that are destined for the runways within their sector.

A secondary screen is utilized by ground controllers as a digital tool called the electronic flight strip system. This tool aids controllers in monitoring the traffic situation at the airport. The screen layout is organized into multiple columns and rows, each serving a specific purpose related to the status of aircraft. The key columns, from left to right, include the passive column, pushback column, clockwise traffic column, counterclockwise traffic column, and Schiphol-East column.

In the passive column, outbound traffic that has been handed over to the ground controller but not yet cleared for pushback is displayed. Once cleared, the aircraft is moved to the pushback column, which consists of sections for pushback pending and ongoing pushbacks. The clockwise and counterclockwise columns represent traffic moving in those directions along the Alpha and Bravo taxiways. The division is based on the direction of travel rather than the specific taxiway being used. The Schiphol-East column is dedicated to general aviation strips, keeping them separated from other traffic.

These sections are among the frequently used ones, but there are additional sections available on the screen. For instance, the "Other" section provides a place for controllers to place flight strips when an aircraft does not fit into any of the predefined sections. There are also sections for transferring flight strips to another controller, indicating when an inbound flight has landed, and marking when a strip is ready to be moved to the Tower (TWR).

The flight strips themselves offer various functions to facilitate controller workflow. Controllers can write on them using different colours and can also position them halfway between columns. This flexibility allows controllers to customize their work process. Once an aircraft has parked, the corresponding strip can be moved out of the screen. To enhance clarity, inbound flight strips are displayed in yellow, while outbound flight strips appear in blue. This colour scheme symbolizes outbound aircraft heading towards the blue sky and inbound aircraft approaching the yellow sand. The information presented on a flight strip typically includes the flight number, inbound and outbound runways, aircraft type, and departure slot time.

In addition to the previously mentioned screens, there are several other screens at the ground control workplace that provide useful information during a shift. One of these screens displays the currently active runways, allowing controllers to stay updated on the runway configurations in use. Another screen provides a view of the incoming and outgoing flights scheduled for the next period of time, assisting controllers in planning and coordinating their operations.

Furthermore, there is a touchscreen interface used for controlling communication. It enables the controller to select the input microphone, which is particularly useful when switching between controllers. This microphone allows the controller to broadcast messages to all aircraft within their sector simultaneously. Additionally, the touchscreen provides convenient access to contact other entities such as the Apron Control, Tower Control, and other ground controllers. This feature proves especially helpful during busy periods, while in quieter moments, communication with Tower Control and other ground controllers is often carried out verbally since they work in the same room.

It's worth noting that there are several more screens providing various forms of information at the ground control working station. However, the screens mentioned above are considered the most essential for supporting effective ground control operations.

### Transferring shifts

A ground controller shift starts with a transfer process that consists of two parts. The first part is known as self-debriefing, where the incoming controller familiarizes themselves with various general conditions. This includes being updated on the frequencies in use, the status of runway lights, runway conditions, and any specific agreements or arrangements with other entities such as Apron Control. It ensures that the starting controller is aware of the prevailing conditions before assuming control.

The second part of the transfer is the actual handover of responsibilities. It is crucial that the starting controller receives a comprehensive overview of the ongoing operations. The controller concluding their shift will debrief the incoming controller about any road closures, diverting SIDs, potential emergencies, and anticipated runway configuration changes. Additionally, the concluding controller will provide information about any existing conflicts or issues that need attention. The information is conveyed in a specific order, progressing from a broad view of the situation to more specific details. This allows the starting controller to develop a complete understanding of the current operational scenario.

The transfer process is not considered complete until the starting controller has obtained a comprehensive situational awareness and understanding of all relevant information. This ensures a smooth transition of responsibilities and promotes continuity in ground control operations.[41]

## 1.4. Experiment

Within this research, an experiment was conducted with ground control experts with the goal to understand where the task load came from in specific high task load situations. The goal of the experiment was to gain a better understanding of the ground control operations at Schiphol Airport while focusing on situations in which the controllers experienced a high task load. This section discusses this experiment.

## Set-up

This subsection discusses the setup of the experiment.

### Data sources

For this experiment, three different data sources were utilized. These three types played a role throughout the entire research. All three of these sources will be discussed below.

#### **ASTRA-data**

The Airport Surveillance Tracker (ASTRA) is a system that integrates the information of different radar sources. It utilizes the radar outputs from multiple ground radar installations and the approach radar. These radar outputs are combined and visually represented on the ASDE screen, as mentioned in section 2.3.

The ASTRA data used in this experiment is the data that comes from these radar sources, it is however already combined into one large dataset. This dataset contains various parameters for each active entity on Schiphol Ground or approaching Schiphol Airport. These parameters are continuously updated at a frequency of one second, aligning with the radar's scanning rate. The data is collected from all active entities, including aircraft moving on the ground and various vehicles operating on the taxiways, which also includes towed aircraft.

The parameters that are recorded for every data entry are the following. Firstly the timestamp at which the data entry took place and the x and y values are recorded. The x and y values are taken in meters from Schiphol Tower and can be used to calculate the location of the aircraft in latitude and longitude. Next, the flight identification code is logged, which is used to separate the different data entries from each other and assign them to a specific aircraft. Lastly, the flight level and ground speed are useful parameters that are provided as well.

#### **Runway configuration data**

This data source is very simple. It shows what runway configuration was used at every moment in time. From this data, the active runways as well as the times at which a configuration change took place can be deduced.

#### **Radio Telephony data**

The R/T data shows the usage of the four different ground control frequencies used at Schiphol Airport. Each of these frequencies is used within a specific sector and is used to communicate with the aircraft in the field. This makes this R/T data a good source of the amount of communication needed with the aircraft in the sector at a specific time. The data is built up in the following way. For every R/T call the starting time, the call duration and the frequency are logged. When two ground control sectors are combined, the frequencies are joined. This can be recognized by the fact that the calls will have an identical starting time and duration. This data source is also used to determine what sectors were active at a certain moment in time.

### Data processing

The data processing was done on the Airport Surveillance Tracker (ASTRA)-data. Since the ASTRA data gives the speed and the location of an aircraft on and around Schiphol Airport, a lot of useful parameters can be calculated from this data. However, it is first needed to know what information would be useful for the experiment. Since the experiment is about recognizing what the cause of the high task load was, it would be useful to have information on how many aircraft were in the different sectors, and what phase of the flight they were in. With this in mind, the following parameters were calculated. This was all done in intervals to make it more accessible for the OE's.

Firstly, the number of aircraft in the different sectors was counted. This was simply done by looking at their location in the ASTRA-data, and recognizing what coordinates belong to what sector. Secondly, the number of active aircraft in the different bays was counted. An aircraft was seen as active after pushback for outbound aircraft and before parking for inbound aircraft. Next, the number of aircraft on the runways was counted per runway and it was noted if it concerned a landing or a take-off. Lastly, the

traffic on the different main taxiways was counted. All of these parameters were calculated for every interval, and this was done for only inbound aircraft, only outbound aircraft and for all aircraft combined.

Next to these processed parameters a tool was created on which the ground traffic during the moments of interest could be visualized. For this tool, the open-source air traffic management software BlueSky was used.[36] This is a Python-based software in which adjustments can be easily made by individual researchers. The newest version of the original source code was used and extended for this experiment. The alternations made were so the software would be able to read the ASTRA data and plot this. Next to this, an easy way to visualize the traffic flows in a way that would closely resemble the ASDE screen was created. A snapshot of what a replay of a specific moment of interest would look like is visible in Figure 2.2.

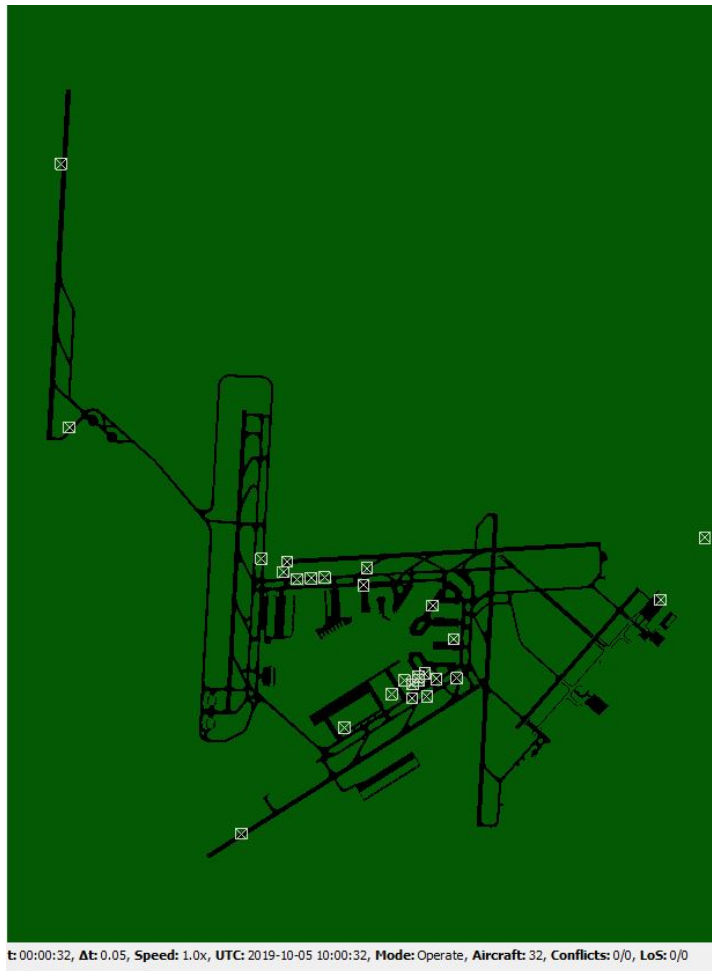

Figure 1.2: BlueSky Experiment Visualisation

### Data set

As the experiment is in collaboration with OEs it is necessary to make it concise while going over all relevant parts. This means that the data set needs to be limited while going over all the most important runway configurations. So for the data set six days were selected of which the R/T data, the runway configuration data and the ASTRA-data were made available, and for which this ASTRA data would be processed. These six different days were selected based on their used runway configurations, which were the following. One day, 9-7-2019 was selected for the northern runway usage, while using runway 06. For the southern runway usage, 18-7-2019 was selected. 2-7-2019 was selected due to the fact that landing was done parallel on runways 36R and 36C, while 9-9-2019 was selected on it parallel starting on runways 18L and 18C. 7-7-2019 was added to the data set because of a lot of landing aircraft on

runway 27. Similarly, because a lot of starting from runway 09, 5-10-2019 was added as the final day to the data set. These different days were selected due to their varying runway configurations, which were decided on together with the OE's. These different days form a set in which all important runway configurations are represented, or a slight variation on the configuration is represented.

#### Experiment execution

The experiment was executed as follows. Firstly, the R/T load was used to recognize moments in time at which the task load was too high. Together with the OE's it was decided that when the R/T load was above 80% for over 10 minutes, the moment would be interesting to research further. All the points in time at which this happened were grouped and discussed together with the OE's. This meant that the processed data with the parameters like amount of aircraft in the field were analyzed, after which the accelerated playback of the situation was analyzed. The group discussed what the possible reason could have been for the high R/T load, which meant that the OE's would walk the group through what exactly happened. The moments of high R/T load were discussed and the different reasons were analyzed to see which were the most prominent.

#### Results

During the experiment there was enough time to elaborately discuss eight moments at which the task load was deemed critical. These eight moments took place along five of the six days that were selected. In one of these moments there was no real cause found for the high task load besides the amount of traffic being high. Since it was deemed that the controllers did everything as they should have, this moment was categorized as having a justified high task load. For the other seven moments this was not the case, and two different causes were identified that helped to create a high task load situation, which are all discussed below. First, the activation of the centre controller is discussed, after which the outbound planning distribution is debated.

#### Centre controller activation

The number of ground controllers working at Schiphol Tower is not constant. At night when there is very little traffic, there is one controller controlling all three sectors. During the day the north and south sectors are almost always active, meaning at least two controllers are active. In this configuration, the centre sector will be merged with the north or the south sector. When the traffic situation asks for it the centre sector will be split from the north or south sector and a third controller will control the centre sector. The decision to split the centre sector and work with three active ground controllers is made by the ground controllers based on the current and predicted traffic situation.

When stating that a cause for a high task load can be the activation of the centre controller, this could mean the following things. Firstly, the sector could not have been split, while this could have helped lower the controller task load. When for example the centre and north sectors are combined, it could be that the controller was experiencing a too high task load because the north sector on its own is providing enough work without merging it with the centre sector. In this case, the centre sector could have been activated to lower the task load of the controller controlling the north sector. This situation did occur in the experiment. A second situation that would be categorized as task load inducing is when the centre sector is split from the others, but too late. In the experiment this also occurred. The reason that this can happen is that the centre sector is only split at the moment at which this seems necessary. This means that when the high task load comes unexpectedly or earlier than expected, the centre sector is not yet split. The splitting of a sector can happen quite fast but it is not an immediate process, as the standby controller will have to be called and come up two floors within Schiphol Tower. The traffic needs to be transferred and the new controller needs to gain situational awareness. The third form of controller activation that could induce the task load is when the centre sector is merged too quickly with another sector. This does not happen as often as in the previous two cases. In this case, the centre sector is merged with one of the other sectors, but after the merging, the controller controlling the merged sector ends up having a too high task load, due to the addition of the centre sector.

#### Outbound planning distribution

When an outbound peak starts during the day, most of the aircraft that are scheduled to leave early in this period have their pushback in the South sector. This means that this sector will have a high task

load at the beginning of this outbound period. However, this flow of traffic will often drive in the same general direction, as all aircraft will go to the take-off runways. So the large traffic stream will move from the south sector to either the north or the centre sector.

Normally this is a process that can be handled by the ground controllers within the limits of accessible task load. The ground controllers do however not determine the moment at which an aircraft calls to notify that it is ready for pushback. This is done by the outbound planners and the gate planners at Schiphol Airport. It often happens that the distribution of the outbound planning is not distributed evenly over the time period for outbound flights. More than once the experiment showed that a very large portion of the total number of outbound flights was planned within the first third of the outbound period. This not only creates a situation in which the task load for the ground controllers is too large, but it also creates a very skewed distribution of this task load within the outbound period. This is due to the fact that when most of the traffic is planned in the first third, the last two-thirds will have a lot less traffic and therefore generate a lot less task load than in the first third of the outbound period.

#### Other gained insights

The two above-discussed subjects were important results of the experiment, however, from the experiment there were more insights gained into how ground control at Schiphol Airport works. These will be discussed below.

The choice of runway configuration and the switches made between different configurations have a significant impact on traffic flows at Schiphol Airport. There are numerous runway configurations used, with a set of eight configurations being responsible for approximately 75% of the airport's operations. Each configuration brings about distinct traffic patterns that affect ground control operations and the potential for conflicting traffic flows.

When a runway configuration switch occurs, there is a change in traffic flows. For instance, a runway can transition from being used for takeoffs to landings, or vice versa. In the former case, the flow of departing aircraft converges in the air, while in the latter case, the flow of arriving aircraft converges on the ground. This switching process is designed to maintain high runway capacity by initiating takeoffs as soon as the last landing has occurred.

To ensure readiness for the runway configuration switch, the aircraft at the front of the takeoff queue must taxi to the runway before the switch takes place. This results in two conflicting traffic flows: aircraft that are still landing and aircraft moving to the parking bays. Particularly, when this occurs at runway 18R/36L, which has only one taxiway leading to it, it presents a demanding task load for controllers.

## Ground Control at Schiphol Airport

This chapter expands on the Ground Control section presented in the preliminary report, providing new insights and in-depth analysis. It covers various essential aspects of ground control operations at Schiphol Airport, including the roles, responsibilities, and objectives of ground controllers. The chapter also delves into the work environment of ground controllers, discussing the equipment they use and the communication systems they rely on. Additionally, it examines the division of ground control sectors at Schiphol Airport and presents findings from a task load experiment, shedding light on factors influencing controller workload. These insights contribute to our understanding of ground control operations and offer valuable considerations for improving operational efficiency and safety at the airport. The experiment conducted with ground control operational experts during this research is discussed at the end of this chapter.

### 2.1. Controller responsibilities and goals

A ground controller is the air traffic controller that an aircraft will communicate with between Apron Planning & Control (APC) and Schiphol Tower Control (TWR), meaning an aircraft will communicate with ground control between pushback and entering the runway for outbound flights, and between exiting the runway and parking for inbound flights. The ground controllers will be responsible for all aircraft that are within these points in time, which is called the taxi phase, and that are inside the manoeuvring areas. Movements on and onto an active runway are excluded for this. [19, p.319][41] On Schiphol Airport the official responsibilities of the ground controller are to provide Aerodrome Control Service, Alerting Service and Flight Information Services to aircraft, towing traffic and other vehicles moving inside the manoeuvring area. [49][41] While the towing traffic is the responsibility of the ground controller, it is being controlled by APC. These two Air Traffic Control (ATC) divisions are currently located in different locations in the tower. However, the process of placing tow control next to ground control at the same location has already started. This is done to create a higher shared situational awareness. [44]

The tasks assigned to a ground controller working for LVNL, as outlined in the Ground Control Manual [41], encompass a range of critical responsibilities. These tasks include:

- Maintaining communication with all flights within the controller's jurisdiction.
- Providing pushback and taxi instructions to departing aircraft.
- Handing off departing aircraft to the runway controller and facilitating the transfer of aircraft crossing an active runway.
- Issuing instructions to prevent collisions and unauthorized runway entry.
- Facilitating the transfer of aircraft to another controller as they leave the controller's sector.
- Informing aircraft about weather conditions and the status of navigational equipment.

- Assigning remote holding places for aircraft.
- Operating taxiway lighting systems.
- Raising alarms and coordinating emergency procedures in case of emergencies.

These tasks collectively ensure the safe and efficient movement of aircraft within the ground control domain, while also maintaining effective communication and upholding safety protocols.

The procedural sequence followed by aircraft at Schiphol Airport after start-up involves several stages. Once start-up clearance is granted by the Outbound Planning (OPL), the corresponding flight strip for that aircraft appears on the ground controller's flight strip screen. The pilot must await completion of all necessary checks and confirmation that the aircraft is prepared for pushback. When the aircraft is ready for pushback, the pilot communicates this information through the assigned sector frequency. The ground controller then either authorizes the pushback or instructs the aircraft to hold until further notice. Often a controller will, when possible, perform a visual check by looking at the aircraft through the tower window to see if pushback clearance is indeed requested when all safety checks are done. This is done as sometimes airlines will request pushback too soon to get an earlier take-off. Subsequently, the pilot contacts the pushback driver after receiving pushback clearance. In the event that pushback does not commence within one minute of receiving permission, the pilot must request permission again by contacting the controller [42].

Once cleared for pushback, the aircraft receives additional instructions. These instructions may involve holding after pushback, waiting for a specific aircraft to pass safely, or commencing taxiing. The controller provides the designated route to the aircraft before taxiing. Typically, the routes utilized align with the standard taxi routes established at Schiphol Airport, although alternative routes may be assigned on occasion. While efforts are made to minimize communication between the pilot and controller during taxiing, additional communication may become necessary. This can occur when an aircraft has priority over another aircraft in a manner that deviates from standard priority rules or when a situation arises within the manoeuvring area. Upon reaching the runway entry point, the controller notifies the aircraft to switch to the tower frequency, effectively concluding their communication. This procedural outline applies to outbound flights. For inbound flights, the process remains similar, with initial contact occurring upon runway exit and final contact transpiring during parking operations.

According to various ground controllers who worked for Air Traffic Control the Netherlands, the three main goals of a ground controller are ensuring safety, sequencing and streaming, which are discussed below.

### Ensuring Safety

The goal of ensuring safety is the most important goal at all times at Schiphol Airport. To achieve this, ground controllers are responsible for ensuring adequate separation between aircraft on the ground, both during taxiing and on the aprons. Maintaining this separation is crucial to prevent potential hazards and mitigate the risk of collisions. Additionally, to optimize sequencing and achieve smooth traffic flow, it is essential to proactively identify and resolve conflicts before they significantly impact the movement of aircraft. By anticipating and resolving conflicts in advance, disruptions to the traffic flow caused by sudden changes in aircraft behaviour can be minimized. Hence, continuous monitoring is an essential task for ground controllers, who must remain vigilant to detect potential conflicts within their assigned area of responsibility.

### Sequencing

Achieving an optimal sequence of outbound traffic is essential to maximize runway utilization and overall runway capacity at Schiphol Airport. The ground controller plays a key role in delivering the traffic to the runway controller in the most favourable order. The sequence provided by the ground controller significantly affects the average waiting time for each aircraft before it can take off following the preceding aircraft. Several factors influence this process, including the specific Standard Instrument Departure (SID) in conjunction with the runway configuration, the wake turbulence categories of the

aircraft, and the utilization of intersections. [41]

SIDs refer to departure routes designed for all IFR-traffic departing from Schiphol Airport. Each take-off runway has multiple SIDs that are designed to optimize airspace utilization while minimizing noise impact on densely populated areas. The connection between SIDs and sequencing arises from the fact that the SIDs assigned to two consecutive departing aircraft determine the time interval required between their departures. If two aircraft with the same SID and similar speeds depart consecutively from the same runway, a longer waiting time is necessary for the second aircraft compared to a scenario where the second aircraft has a different SID. Therefore, it is advantageous for the ground controller to adjust the sequence of aircraft based on their SIDs to avoid consecutive departures with the same SID.

Furthermore, the order in which aircraft of different wake turbulence categories take off can influence runway capacity at Schiphol Airport. Thus, the sequencing decisions made by the ground controller directly impact runway capacity, taking into account both the wake turbulence category and the assigned SID of each aircraft. Additionally, during sequence creation, the ground controller has the flexibility to assign aircraft to start at specific intersections instead of at the beginning of the runway. However, intersection departures are only employed when operationally necessary. For instance, if a series of aircraft with similar SIDs or unfavourable wake turbulence categories are waiting in succession at the start of the runway, the ground controller may choose to utilize an intersection departure to insert an aircraft between them, thereby improving the overall sequence. [41]

By considering these factors and making informed sequencing decisions, the ground controller contributes to optimizing runway capacity, minimizing delays, and ensuring an efficient and safe departure process for aircraft at Schiphol Airport.

### Streaming

The concept of streaming in ground control operations aims to facilitate the continuous movement of aircraft through the manoeuvring area with minimal delays. The primary objective of effective streaming is to ensure that all traffic can progress smoothly and efficiently. In pursuit of this goal, priority is given to moving aircraft over stationary aircraft, even if the moving aircraft deviate slightly from the most optimal route. This preference comes from the inherent flexibility of a moving aircraft compared to a stationary one.

When aircraft remain stationary for an extended period, especially larger aircraft, it takes longer for them to resume motion once they start moving again. Therefore, for optimal streaming, it is advantageous to keep heavy aircraft in motion and halt smaller aircraft when necessary, as the smaller aircraft can resume movement more quickly after being stopped. By prioritizing the continuous flow of larger aircraft, potential delays and disruptions in the traffic stream can be minimized.

## 2.2. Sectors

Amsterdam Schiphol Airport employs ground controllers who operate from two distinct control towers. During peak occupancy, three ground controllers are assigned to Schiphol Tower Center, while one ground controller operates from Schiphol Tower West. Ground traffic management at Schiphol Airport is organized into different geographical regions, with each region overseen by one to four controllers. Collectively, these controllers are responsible for managing four sectors: North, West, South, and Centre.

Among these sectors, the North sector is the largest, encompassing three runways: 04/22, 09/27 and 18L/36R. The South sector contains runway 06/24, while the Centre sector is responsible for 18C/36C. Lastly, the West sector is associated with the more remote 18R/36L. This division of sectors and runways ensures effective management of ground traffic at the airport. [49, p.13][41]

It is worth noting that the ground controller assigned to the West sector is always positioned at TWR-W. This arrangement is necessary because runway 18R/36L is situated at a considerable distance from the main area of Schiphol, making it difficult to observe from TWR-C. Thus, by stationing the West sector controller at TWR-W, optimal visual coverage and oversight of operations on runway 18R/36L

are ensured. The visual representation of the ground control sectors and their associated runways is depicted in Figure 2.1, providing an overview of the sector allocation and the spatial layout of Schiphol Airport's ground control operations.

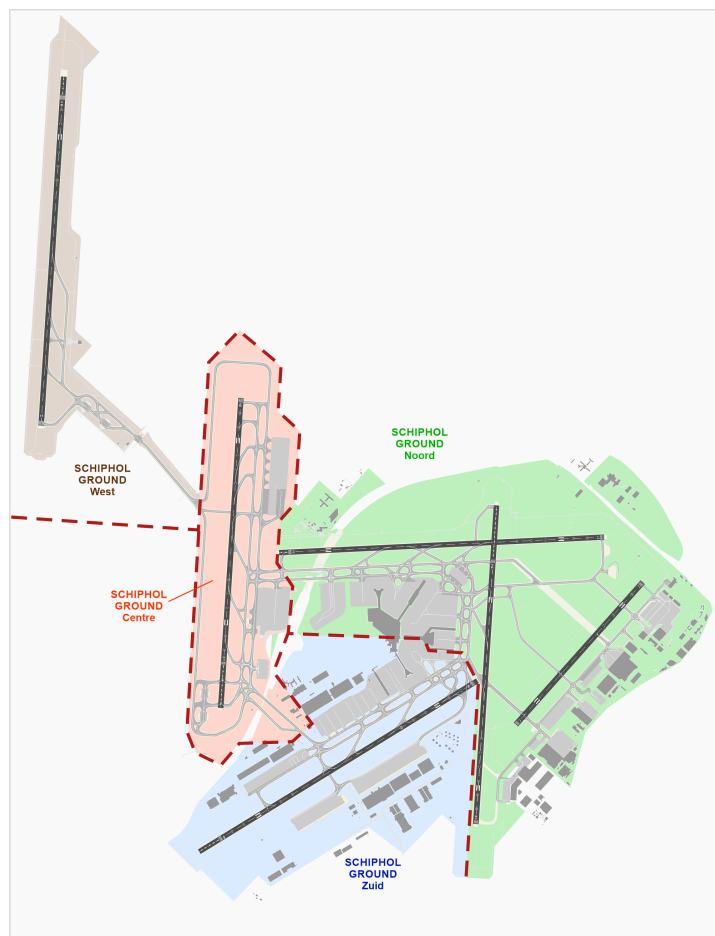

Figure 2.1: Ground Control Sectors [41]

The layout of the ground control sectors at Schiphol Airport remains consistent, with only two areas that have the flexibility to be transferred between sectors during operations. These transfers are carried out after coordination among all controllers.

The first area is taxiway Quebec, situated at the southeast end of the Centre sector. Under normal circumstances, it falls within the Centre sector. However, if traffic demands require it, this area can be temporarily transferred to the South sector. Similarly, the D-pier, the pier shaped like a tuning fork located on the northern border between the South and North sectors, is typically part of the North sector. Nevertheless, it can be temporarily transferred to the South sector based on operational needs.

These temporary transfers of specific areas can be performed by the ground controllers themselves, under the supervision of their supervisor, within the control tower. It is important to note that these adjustments are not logged, as they are small-scale and temporary alterations made to accommodate the dynamic traffic conditions and optimize sector workload distribution.

### 2.3. Controller workplace

Within this section, the workplace of the controller is discussed. This means the physical place and all the equipment used by a controller, as well as the communication lines a controller uses during the job.

Next to this the transferring of shifts between different ground controllers is discussed in this section.

### Tower entities

Within the tower, there are a lot of controlling entities besides the ground controllers. Together they control everything in the manoeuvring area, as well as the Schiphol Control Zone (CTR). All roles within the TWR-C that have a link with the ground controllers will be discussed.

#### Tower Supervisor (SUP)

The Tower Supervisor (SUP) plays a crucial role in the overall tower process at Schiphol Airport, assuming responsibility for delivering all ATC services within the manoeuvring area and the CTR surrounding the airport. The primary objective of the SUP is to ensure the provision of high-quality ATC services. Several key tasks are assigned to the SUP:

Firstly, the SUP is responsible for monitoring all personnel involved in the tower operations, including the ground controller. As the overall authority overseeing the tower process, it is essential for the SUP to stay informed about the status of operations. This entails monitoring the activities of other individuals and actively coordinating with them. Secondly, the SUP holds ultimate responsibility for making significant decisions regarding the tower process. This includes responding to weather forecasts and formulating strategies for emergency situations. These critical decisions are within the purview of the SUP.

Another important responsibility of the SUP is determining the runway configuration to be used. However, this task is not solely the responsibility of the SUP. The decision on runway configuration is made in coordination with the Approach Supervisor and the Flow Manager Aircraft. The Approach Supervisor, similar to the SUP, carries out corresponding responsibilities within the Approach Control unit. The Flow Manager Aircraft is accountable for managing various aspects of aircraft operational flows on the airside.

The communication between the ground controller and the SUP occurs through face-to-face interaction since both are located on the 12th floor of TWR-C. Although communication between them happens frequently, it is not considered one of the most heavily utilized communication channels for the ground controller. The SUP is active during the day, and during the night, a standby SUP is available to be deployed as required.

#### Runway Controller (RC)

The Runway Controllers at Schiphol Airport are responsible for providing Air Traffic Control services in the vicinity of the landing area, which specifically includes the runways and their exits. They play a crucial role in the ATC chain, positioned between Ground Control and Approach Control. When an aircraft is in line for takeoff at one of the runway entries, it is handed over from the Ground Controller to the Runway Controller. Similarly, the runway controller will hand over an aircraft to the ground controller as soon as it leaves the runway after landing.

The Runway Controllers have various important tasks, with the primary focus on preventing collisions between aircraft while ensuring the safe and efficient flow of inbound and outbound traffic. Their responsibilities primarily encompass aircraft in the landing or takeoff phase. Additionally, similar to Ground Controllers, Runway Controllers provide Flight Information Services and Alerting Services. They are responsible for granting permission to cross active runways, a request that can be made by Ground Controllers or the Second Tower Assistant. [52]

In terms of communication, Runway Controllers have two frequently used communication lines, one with Ground Control and the other with Approach Control. However, for the purposes of this research, the communication line with Ground Control is more relevant. This communication takes place face-to-face since both Ground Controllers and Runway Controllers are located on the 12th floor of TWR-C. Typically, this communication involves requests to cross the runway, although additional communication may be necessary in situations such as abnormal conditions on taxiways or when certain runway exits are no longer preferred.

### **Outbound Planning (OPL)**

The Outbound Planning plays a crucial role within the tower process at Schiphol Airport. Their main responsibility is to create an optimal departure plan for all outbound traffic, which significantly impacts the flow of outbound aircraft and, consequently, the work of the ground controllers. The OPL determines the specific times at which aircraft should be ready for start-up, as they will hand over the aircraft to the ground controllers at these designated points. Given that the majority of outbound traffic requests start-up during the outbound peak period, the outbound planner plays a vital role in distributing these start-up requests throughout the peak period. This distribution of start-up requests is crucial in managing the flow of outbound traffic effectively. [52]

The Outbound Planner, similar to the ground controllers, is located on the 12th floor of TWR-C. Communication between the outbound planner and the ground controllers takes place face-to-face, and it is considered one of the more intensively used communication links for the ground controllers. However, it is important to note that the communication primarily occurs with the ground controllers who are responsible for the North or South sector, as these are the sectors from which the outbound planning originates.

### **Tower Assistant 2 (TWR ASS-2)**

The Tower Assistant 2 (TWR ASS-2) is another important actor located on the 12th floor of TWR-C at Schiphol Airport. The TWR ASS-2 has a supportive role, primarily assisting the ground and runway controller in their tasks. Additionally, the TWR ASS-2 serves as a communication intermediary between the runway controller, ground controller, and various entities across the airport. These entities include the controllers in TWR-W, vehicle drivers in the manoeuvring area, and airport services or emergency personnel. The TWR ASS-2 acts as a liaison, relaying information and instructions between these parties.

Moreover, the TWR ASS-2 has the ability to control vehicles in the manoeuvring area, but this is done under the responsibility of the ground controllers. The TWR ASS-2's involvement in vehicle control is coordinated with and supervised by the ground controllers. [52] The communication between the TWR ASS-2 and the ground controller is frequent and intensive, and it occurs face-to-face. The nature of this communication often involves the TWR ASS-2 informing either the ground controller or the runway controller about their actions or tasks that need to be performed.

### **Apron Planning & Control (APC)**

The Apron Planning & Control (APC) has an important role at Amsterdam Schiphol Airport that falls under the responsibility of the airport itself, rather than LVNL. Unlike the other roles discussed earlier, the APC is located on the 10th floor of TWR-C, which is different from the 12th floor where the other roles are situated. As a result, the communication between the APC and the ground controller is done via line communication rather than face-to-face interaction.[52]

The APC has two main areas of responsibility: Apron Control and Planning. For the purpose of ground control and this research, the Apron responsibilities are most relevant. The APC has to ensure the efficient and safe handling of towing traffic within the airport. Towing traffic involves smaller vehicles that are responsible for moving aircraft from one location to another without taxiing. While the ultimate responsibility for all moving entities in the manoeuvring area lies with the ground controllers, the APC specifically handles the towing traffic. This creates a need for shared communication between the APC and the ground controller. In certain situations, the APC may need to request permission from the ground controller to cross specific areas of the manoeuvring area with the towing traffic. Therefore, the communication line between the APC and the ground controller is regularly used, and it is often initiated from the APC's side.

### **Communication reduction**

In the previous sections, we discussed the various roles connected to ground control operations at Amsterdam Schiphol Airport. These roles have direct communication links with ground controllers. However, it is important to note that even the most frequently used communication links are not actively utilized very often. This is primarily due to the increased automation in communication pro-

cesses. In the past, when TWR-C still relied on paper flight strips, every aircraft had to be physically transferred to the respective controller, resulting in a significant amount of communication. However, with the adoption of electronic flight strips at both TWR-C and TWR-W, the need for this type of communication has been eliminated. Aircraft can now be transferred to another controller without the need for direct communication between controllers.

This shift to electronic flight strips has significantly reduced the communication required between ground controllers themselves, as well as between ground controllers and runway controllers or the outbound planner. As a result, there is no heavily used communication link in operation. The most common communication occurs between ground controllers when issues arise that impact traffic flow in other sectors or when considering rearranging active sectors. In such situations, they need to communicate and collaborate to address the problem effectively.

## Workplace

At Tower Centre, the ground controllers have a direct and unobstructed view of all runways except for the runway 18R/36L, which is located far away. However, they have a clear line of sight to almost all taxiways, apron areas, and gates that are situated to the east of runway 18C/36C. The layout of the working stations for the controllers is strategically designed to provide them with optimal visibility of the sector they are responsible for. This arrangement ensures that controllers can effectively monitor and manage the air and ground traffic within their designated sector. At their workplaces, there are several digital tools that play a crucial role in enhancing situational awareness and overall safety during operations. These tools are presented on multiple screens, providing controllers with important information. One of the screens that significantly contributes to situational awareness is the Airport Surface Detection Equipment (Airport Surface Detection Equipment).

The Airport Surface Detection Equipment is a vital tool displayed on one of the screens at the ground controllers' workplaces. ASDE provides a top-down view of Amsterdam Schiphol Airport, presenting real-time information about the location and movements of active vehicles on the ground. The data used by ASDE is gathered from various primary and secondary radar sources. By observing the ASDE screen, controllers can quickly assess the positions and directions of vehicles in motion, thereby enhancing their situational awareness. This tool is particularly valuable during operations with reduced visibility, as it enables controllers to maintain a clear understanding of ground movements. The ASDE radar has a refresh rate of one second, ensuring that the displayed information is relatively up-to-date. Additionally, the radar screen also includes a visual representation of the Tower radar, allowing ground controllers to monitor approaching airborne flights that are destined for the runways within their sector.

A secondary screen is utilized by ground controllers as a digital tool called the electronic flight strip system. This tool aids controllers in monitoring the traffic situation at the airport. The screen layout is organized into multiple columns and rows, each serving a specific purpose related to the status of aircraft. The key columns, from left to right, include the passive column, pushback column, clockwise traffic column, counterclockwise traffic column, and Schiphol-East column.

In the passive column, outbound traffic that has been handed over to the ground controller but not yet cleared for pushback is displayed. Once cleared, the aircraft is moved to the pushback column, which consists of sections for pushback pending and ongoing pushbacks. The clockwise and counterclockwise columns represent traffic moving in those directions along the Alpha and Bravo taxiways. The division is based on the direction of travel rather than the specific taxiway being used. The Schiphol-East column is dedicated to general aviation strips, keeping them separated from other traffic.

These sections are among the frequently used ones, but there are additional sections available on the screen. For instance, the "Other" section provides a place for controllers to place flight strips when an aircraft does not fit into any of the predefined sections. There are also sections for transferring flight strips to another controller, indicating when an inbound flight has landed, and marking when a strip is ready to be moved to the Tower (TWR).

The flight strips themselves offer various functions to facilitate controller workflow. Controllers can write on them using different colours and can also position them halfway between columns. This flexibility allows controllers to customize their work process. Once an aircraft has parked, the corresponding strip can be moved out of the screen. To enhance clarity, inbound flight strips are displayed in yellow, while outbound flight strips appear in blue. This colour scheme symbolizes outbound aircraft heading towards the blue sky and inbound aircraft approaching the yellow sand. The information presented on a flight strip typically includes the flight number, inbound and outbound runways, aircraft type, and departure slot time.

In addition to the previously mentioned screens, there are several other screens at the ground control workplace that provide useful information during a shift. One of these screens displays the currently active runways, allowing controllers to stay updated on the runway configurations in use. Another screen provides a view of the incoming and outgoing flights scheduled for the next period of time, assisting controllers in planning and coordinating their operations.

Furthermore, there is a touchscreen interface used for controlling communication. It enables the controller to select the input microphone, which is particularly useful when switching between controllers. This microphone allows the controller to broadcast messages to all aircraft within their sector simultaneously. Additionally, the touchscreen provides convenient access to contact other entities such as the Apron Control, Tower Control, and other ground controllers. This feature proves especially helpful during busy periods, while in quieter moments, communication with Tower Control and other ground controllers is often carried out verbally since they work in the same room.

It's worth noting that there are several more screens providing various forms of information at the ground control working station. However, the screens mentioned above are considered the most essential for supporting effective ground control operations.

### Transferring shifts

A ground controller shift starts with a transfer process that consists of two parts. The first part is known as self-debriefing, where the incoming controller familiarizes themselves with various general conditions. This includes being updated on the frequencies in use, the status of runway lights, runway conditions, and any specific agreements or arrangements with other entities such as Apron Control. It ensures that the starting controller is aware of the prevailing conditions before assuming control.

The second part of the transfer is the actual handover of responsibilities. It is crucial that the starting controller receives a comprehensive overview of the ongoing operations. The controller concluding their shift will debrief the incoming controller about any road closures, diverting SIDs, potential emergencies, and anticipated runway configuration changes. Additionally, the concluding controller will provide information about any existing conflicts or issues that need attention. The information is conveyed in a specific order, progressing from a broad view of the situation to more specific details. This allows the starting controller to develop a complete understanding of the current operational scenario.

The transfer process is not considered complete until the starting controller has obtained a comprehensive situational awareness and understanding of all relevant information. This ensures a smooth transition of responsibilities and promotes continuity in ground control operations.[41]

## 2.4. Experiment

Within this research, an experiment was conducted with ground control experts with the goal to understand where the task load came from in specific high task load situations. The goal of the experiment was to gain a better understanding of the ground control operations at Schiphol Airport while focusing on situations in which the controllers experienced a high task load. This section discusses this experiment.

## Set-up

This subsection discusses the setup of the experiment.

### Data sources

For this experiment, three different data sources were utilized. These three types played a role throughout the entire research. All three of these sources will be discussed below.

#### ASTRA-data

The Airport Surveillance Tracker (ASTRA) is a system that integrates the information of different radar sources. It utilizes the radar outputs from multiple ground radar installations and the approach radar. These radar outputs are combined and visually represented on the ASDE screen, as mentioned in section 2.3.

The ASTRA data used in this experiment is the data that comes from these radar sources, it is however already combined into one large dataset. This dataset contains various parameters for each active entity on Schiphol Ground or approaching Schiphol Airport. These parameters are continuously updated at a frequency of one second, aligning with the radar's scanning rate. The data is collected from all active entities, including aircraft moving on the ground and various vehicles operating on the taxiways, which also includes towed aircraft.

The parameters that are recorded for every data entry are the following. Firstly the timestamp at which the data entry took place and the x and y values are recorded. The x and y values are taken in meters from Schiphol Tower and can be used to calculate the location of the aircraft in latitude and longitude. Next, the flight identification code is logged, which is used to separate the different data entries from each other and assign them to a specific aircraft. Lastly, the flight level and ground speed are useful parameters that are provided as well.

#### Runway configuration data

This data source is very simple. It shows what runway configuration was used at every moment in time. From this data, the active runways as well as the times at which a configuration change took place can be deduced.

#### Radio Telephony data

The R/T data shows the usage of the four different ground control frequencies used at Schiphol Airport. Each of these frequencies is used within a specific sector and is used to communicate with the aircraft in the field. This makes this R/T data a good source of the amount of communication needed with the aircraft in the sector at a specific time. The data is built up in the following way. For every R/T call the starting time, the call duration and the frequency are logged. When two ground control sectors are combined, the frequencies are joined. This can be recognized by the fact that the calls will have an identical starting time and duration. This data source is also used to determine what sectors were active at a certain moment in time.

### Data processing

The data processing was done on the Airport Surveillance Tracker (ASTRA)-data. Since the ASTRA data gives the speed and the location of an aircraft on and around Schiphol Airport, a lot of useful parameters can be calculated from this data. However, it is first needed to know what information would be useful for the experiment. Since the experiment is about recognizing what the cause of the high task load was, it would be useful to have information on how many aircraft were in the different sectors, and what phase of the flight they were in. With this in mind, the following parameters were calculated. This was all done in intervals to make it more accessible for the OE's.

Firstly, the number of aircraft in the different sectors was counted. This was simply done by looking at their location in the ASTRA-data, and recognizing what coordinates belong to what sector. Secondly, the number of active aircraft in the different bays was counted. An aircraft was seen as active after pushback for outbound aircraft and before parking for inbound aircraft. Next, the number of aircraft on the runways was counted per runway and it was noted if it concerned a landing or a take-off. Lastly, the

traffic on the different main taxiways was counted. All of these parameters were calculated for every interval, and this was done for only inbound aircraft, only outbound aircraft and for all aircraft combined.

Next to these processed parameters a tool was created on which the ground traffic during the moments of interest could be visualized. For this tool, the open-source air traffic management software BlueSky was used.[36] This is a Python-based software in which adjustments can be easily made by individual researchers. The newest version of the original source code was used and extended for this experiment. The alternations made were so the software would be able to read the ASTRA data and plot this. Next to this, an easy way to visualize the traffic flows in a way that would closely resemble the ASDE screen was created. A snapshot of what a replay of a specific moment of interest would look like is visible in Figure 2.2.

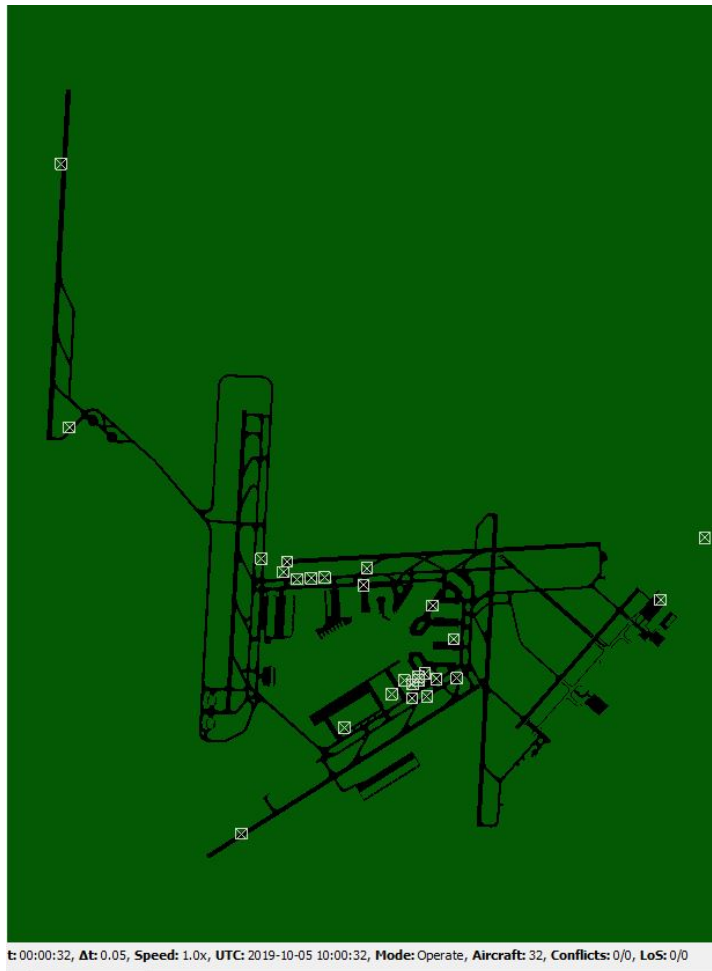

Figure 2.2: BlueSky Experiment Visualisation

### Data set

As the experiment is in collaboration with OEs it is necessary to make it concise while going over all relevant parts. This means that the data set needs to be limited while going over all the most important runway configurations. So for the data set six days were selected of which the R/T data, the runway configuration data and the ASTRA-data were made available, and for which this ASTRA data would be processed. These six different days were selected based on their used runway configurations, which were the following. One day, 9-7-2019 was selected for the northern runway usage, while using runway 06. For the southern runway usage, 18-7-2019 was selected. 2-7-2019 was selected due to the fact that landing was done parallel on runways 36R and 36C, while 9-9-2019 was selected on it parallel starting on runways 18L and 18C. 7-7-2019 was added to the data set because of a lot of landing aircraft on

runway 27. Similarly, because a lot of starting from runway 09, 5-10-2019 was added as the final day to the data set. These different days were selected due to their varying runway configurations, which were decided on together with the OE's. These different days form a set in which all important runway configurations are represented, or a slight variation on the configuration is represented.

#### Experiment execution

The experiment was executed as follows. Firstly, the R/T load was used to recognize moments in time at which the task load was too high. Together with the OE's it was decided that when the R/T load was above 80% for over 10 minutes, the moment would be interesting to research further. All the points in time at which this happened were grouped and discussed together with the OE's. This meant that the processed data with the parameters like amount of aircraft in the field were analyzed, after which the accelerated playback of the situation was analyzed. The group discussed what the possible reason could have been for the high R/T load, which meant that the OE's would walk the group through what exactly happened. The moments of high R/T load were discussed and the different reasons were analyzed to see which were the most prominent.

#### Results

During the experiment there was enough time to elaborately discuss eight moments at which the task load was deemed critical. These eight moments took place along five of the six days that were selected. In one of these moments there was no real cause found for the high task load besides the amount of traffic being high. Since it was deemed that the controllers did everything as they should have, this moment was categorized as having a justified high task load. For the other seven moments this was not the case, and two different causes were identified that helped to create a high task load situation, which are all discussed below. First, the activation of the centre controller is discussed, after which the outbound planning distribution is debated.

#### Centre controller activation

The number of ground controllers working at Schiphol Tower is not constant. At night when there is very little traffic, there is one controller controlling all three sectors. During the day the north and south sectors are almost always active, meaning at least two controllers are active. In this configuration, the centre sector will be merged with the north or the south sector. When the traffic situation asks for it the centre sector will be split from the north or south sector and a third controller will control the centre sector. The decision to split the centre sector and work with three active ground controllers is made by the ground controllers based on the current and predicted traffic situation.

When stating that a cause for a high task load can be the activation of the centre controller, this could mean the following things. Firstly, the sector could not have been split, while this could have helped lower the controller task load. When for example the centre and north sectors are combined, it could be that the controller was experiencing a too high task load because the north sector on its own is providing enough work without merging it with the centre sector. In this case, the centre sector could have been activated to lower the task load of the controller controlling the north sector. This situation did occur in the experiment. A second situation that would be categorized as task load inducing is when the centre sector is split from the others, but too late. In the experiment this also occurred. The reason that this can happen is that the centre sector is only split at the moment at which this seems necessary. This means that when the high task load comes unexpectedly or earlier than expected, the centre sector is not yet split. The splitting of a sector can happen quite fast but it is not an immediate process, as the standby controller will have to be called and come up two floors within Schiphol Tower. The traffic needs to be transferred and the new controller needs to gain situational awareness. The third form of controller activation that could induce the task load is when the centre sector is merged too quickly with another sector. This does not happen as often as in the previous two cases. In this case, the centre sector is merged with one of the other sectors, but after the merging, the controller controlling the merged sector ends up having a too high task load, due to the addition of the centre sector.

#### Outbound planning distribution

When an outbound peak starts during the day, most of the aircraft that are scheduled to leave early in this period have their pushback in the South sector. This means that this sector will have a high task

load at the beginning of this outbound period. However, this flow of traffic will often drive in the same general direction, as all aircraft will go to the take-off runways. So the large traffic stream will move from the south sector to either the north or the centre sector.

Normally this is a process that can be handled by the ground controllers within the limits of accessible task load. The ground controllers do however not determine the moment at which an aircraft calls to notify that it is ready for pushback. This is done by the outbound planners and the gate planners at Schiphol Airport. It often happens that the distribution of the outbound planning is not distributed evenly over the time period for outbound flights. More than once the experiment showed that a very large portion of the total number of outbound flights was planned within the first third of the outbound period. This not only creates a situation in which the task load for the ground controllers is too large, but it also creates a very skewed distribution of this task load within the outbound period. This is due to the fact that when most of the traffic is planned in the first third, the last two-thirds will have a lot less traffic and therefore generate a lot less task load than in the first third of the outbound period.

#### Other gained insights

The two above-discussed subjects were important results of the experiment, however, from the experiment there were more insights gained into how ground control at Schiphol Airport works. These will be discussed below.

The choice of runway configuration and the switches made between different configurations have a significant impact on traffic flows at Schiphol Airport. There are numerous runway configurations used, with a set of eight configurations being responsible for approximately 75% of the airport's operations. Each configuration brings about distinct traffic patterns that affect ground control operations and the potential for conflicting traffic flows.

When a runway configuration switch occurs, there is a change in traffic flows. For instance, a runway can transition from being used for takeoffs to landings, or vice versa. In the former case, the flow of departing aircraft converges in the air, while in the latter case, the flow of arriving aircraft converges on the ground. This switching process is designed to maintain high runway capacity by initiating takeoffs as soon as the last landing has occurred.

To ensure readiness for the runway configuration switch, the aircraft at the front of the takeoff queue must taxi to the runway before the switch takes place. This results in two conflicting traffic flows: aircraft that are still landing and aircraft moving to the parking bays. Particularly, when this occurs at runway 18R/36L, which has only one taxiway leading to it, it presents a demanding task load for controllers.

3

Figures



# Bibliography

- [1] F.M. Dekking et al. A Modern Introduction to Probability and Statistics: Understanding Why and How. Number 1. Springer Nature, Cham, Switzerland, 2005.
- [2] J. Avery and H. Balakrishnan. Predicting airport runway configuration: A discrete-choice modeling approach. Proceedings from 8th USA/Europe Air Traffic Management Research and Development Seminar, Lisbon, Portugal, 2015.
- [3] A. de Leege and C. Janssen. Probabilistic runway and capacity forecasting using machine learning to support decision making. 6th SESAR Innovation Days, 10 2016.
- [4] D. de Waard. The measurement of drivers' mental workload. The traffic research centre VSC, University of Groningen, Groningen, 1996.
- [5] J. de Winter and S.D. Gosling. Comparing the pearson and spearman correlation coefficients across distributions and sample sizes: A tutorial using simulations and empirical data. Psychological Methods, 21(3):273–290, 2016.
- [6] L.E. Eberly. Topics in Biostatistics- Multiple Linear Regression. Humana Press Inc, Totowa, New Jersey, USA, 2007.
- [7] A. Koros et al. Complexity in Air Traffic Control Towers: A Field Study Part 1. Complexity Factors. Number Report No. DOT/FAA/CT-TN03/14. FAA William J Hughes Technical Center, Atlantic City, New Jersey, USA, 2003.
- [8] A. Majumdar et al. En-route sector capacity estimation methodologies: An international survey. Journal of Air Transport Management, 11(06):375–387, 2005.
- [9] A.J. Masalonis et al. Dynamic density and complexity metrics for realtime traffic flow management. Proceedings of the 5th USA/Europe Air Traffic Management RD Seminar, Budapest, Hungary, 2003.
- [10] B. Sridhar et al. Airspace complexity and its application in air traffic management. Proceedings of the 2nd USA/Europe Air Traffic Management RD Seminar, Orlando, USA, 1998.
- [11] C. Meckiff et al. The Tactical Load Smoother for Multi-Sector Planning. Number Paper 40. EUROCONTROL, Bretigny, France, 1998.
- [12] C.A. Manning et al. Using air traffic control taskload measures and communication events to predict subjective workload. Technical Report FAA, 06 2002.
- [13] C.G. Davis et al. The influence of selected sector characteristics upon ARTCC controller activities. Number Report No. FAA/BRD-301. The Matrix Cooperation, Arlington, Virginia, USA, 1963.
- [14] I.V. Laudeman et al. Dynamic density: An air traffic management metric. Report No. NASA/TM-1998-112226, 1998.
- [15] K. Brookhuis et al. Driving with a congestion assistant, mental workload and acceptance. Applied Ergonomics, pages 1019–1025, 2009.
- [16] M. Tranmer et al. Multiple linear regression. Cathie Marsh Institute Working Paper 2020-01., 01 2020.
- [17] M.A. Recarte et al. Mental workload while driving: effects on visual search, discrimination and decision making. Journal of Experimental Psychology, 9(2):119–137, 2003.

- [18] M.P. Keuken et al. Total and size-resolved particle number and black carbon concentrations in urban areas near schiphol airport (the netherlands). *Atmospheric Environment*, 104:132–142, 03 2015.
- [19] N.J. Ashford et al. *Airport Operations*, volume 3. McGrawHill, New York, 2013.
- [20] P. Hermes et al. Solution-space-based analysis of the difficulty of aircraft merging tasks. *Journal of Aircraft*, 46(6):1995–2015, November-December 2009.
- [21] P. Kopardekar et al. Airspace complexity measurement: An air traffic control simulation analysis. *International Journal of Industrial Engineering*, 16:61–70, 2009.
- [22] R. Duda et al. *Pattern Classification*. John Wiley Sons, Hoboken, New Jersey, USA, 2000.
- [23] W. Sardjono et al. Study of runway crosswind and tailwind potential for airport sustainability: A study of soekarno hatta airport, cengkareng, indonesia. *IOP Conference: Earth and Environment Science*, 729, 2020.
- [24] W.B. Rouse et al. Modelling the dynamics of mental workload and human performance in complex systems. *IEEE Transactions on systems, cybernetics*, 23:1662–1671, 1993.
- [25] W.T. Kuhar et al. Impact of automation upon air traffic control system productivity/capacity (ARTS-III). Number Report No. DOT/FAA/CT-TN93/39. Federal Aviation Administration, Atlantic City, New Jersey, USA, 1976.
- [26] Y. Jiang et al. A collaborative optimization model for ground taxi based aircraft priority. *Mathematical Problems in Engineering*, (Article ID 854364), 2013.
- [27] W. Xu et al. A comparative analysis of spearman’s rho and kendall’s tau in normal and contaminated normal models. *Signal Processing*, (93):261–276, 2013.
- [28] Federal Aviation Administration (FAA). Wake turbulence, 2022. URL [https://www.faa.gov/air\\_traffic/publications/atpubs/aim\\_html/chap7\\_section\\_4.html#:~:text=Wake%20turbulence%20is%20a%20function,and%20direction%20of%20the%20vortices](https://www.faa.gov/air_traffic/publications/atpubs/aim_html/chap7_section_4.html#:~:text=Wake%20turbulence%20is%20a%20function,and%20direction%20of%20the%20vortices).
- [29] G.S. Gilmour. The interpretation of mallows’s cp-statistic. *Journal of Royal Statistics Society*, D-45(1):49–56, 1996.
- [30] Royal Schiphol Group. Annual report 2021 - our capacity & infrastructure, 2021. URL <https://www.annualreportschiphol.com/trafficreview2021/infrastructure>.
- [31] Royal Schiphol Group. Completing schiphol’s dual taxiway system, 2022. URL <https://www.schiphol.nl/en/projects/page/completing-schiphols-dual-taxiway-system/>.
- [32] Royal Schiphol Group. Path to reduced noise nuisance, 2022. URL <https://www.schiphol.nl/en/schiphol-as-a-neighbour/page/noise-and-runway-combinations/>.
- [33] The Guardian. Heathrow’s two runways - how do other airports compare, 2015. URL <https://www.theguardian.com/world/datablog/2015/jul/02/heathrow-two-runways-other-airports-europe-compare>.
- [34] J.N. Hallock and F. Holzapfel. A review of recent wake vortex research for increasing airport capacity. *Progress in Aerospace Sciences*, 98:27–36, 2018.
- [35] J.M. Histon. Introducing structural considerations into complexity metrics. *ATC Quarterly*, 10, 5 1995.
- [36] J.M. Hoekstra and J. Ellerbroek. Bluesky atc simulator project: an open data and open source approach. *The International Conference for Research on Air Transportation*, 7, 06 2016.
- [37] T. Kolos-Lakatos. The influence of runway occupancy time and wake vortex separation requirements on runway throughput. *Massachusetts Institute of Technology*, pages 19–35, 03 2013.

- [38] P. Kopardekar. Dynamic density: A review of proposed variables. Federal Aviation Administration William J. Hughes Technical Center, 2000.
- [39] P. Kopardekar. Dynamic density: Measuring and predicting sector complexity. Proceedings of the 21st Digital Aviation Systems Conference, pages 63–102, 2002.
- [40] P. Kopardekar and S. Magyarits. Measurement and prediction of dynamic density. FAA Report No. dd\_atm2003\_7-03, 2003.
- [41] Air Traffic Control The Netherlands (LVNL). Werkboek ut spl gnd. Internal Document.
- [42] Air Traffic Control The Netherlands (LVNL). Limitations obstaclefields (beperkingen obstakelvlakken. Internal Document LVNL, 01 2019.
- [43] Air Traffic Control The Netherlands (LVNL). Eham - amsterdam schiphol, 2021. URL <https://www.lvn1.nl/eaip/2021-12-16-AIRAC/html/eAIP/EH-AD-2.EHAM-en-GB.html>.
- [44] Air Traffic Control The Netherlands (LVNL). Vemer tow control. Internal Document LVNL, 03 2021.
- [45] Air Traffic Control The Netherlands (LVNL). Amsterdam/schiphol aerodrome ground movement chart, 2022. URL <https://www.lvn1.nl/eaip/2021-12-16-AIRAC/graphics/eAIP/EH-AD-2.EHAM-GMC-A2s.pdf>.
- [46] Air Traffic Control The Netherlands (LVNL). Meteorological influences, 2022. URL <https://en.lvn1.nl/environment/runway-use/meteorological-influences>.
- [47] Air Traffic Control The Netherlands (LVNL). Preferred sequence, 2022. URL <https://en.lvn1.nl/environment/runway-use/preferred-sequence>.
- [48] Air Traffic Control The Netherlands (LVNL). Runway use, 2022. URL <https://en.lvn1.nl/environment/runway-use>.
- [49] Air Traffic Control The Netherlands (LVNL). Conops schiphol ground control. Internal Document LVNL, 01 2022.
- [50] C. Mallow. Some comments on cp. *Technometrics*, 15:661–676, 1973.
- [51] C.A. Manning and E.M. Pfeleiderer. Relationship of Sector Activity and Sector Complexity to Air Traffic Controller task load. Number Report No. DOT/FAA/AM-06/29. FAA Civil Aerospace Medical Institute, Oklahoma City, Oklahoma, USA, 2006.
- [52] MovingDot. Functional analysis of schiphol twr-c. Knowledge and Development Centre Mainport Schiphol Report, 10 2017.
- [53] D.J. Olive. *Linear Regression*. Springer International Publishing, Cham, Switzerland, 2017.
- [54] D.H. Potterfield. Evaluating controller communication time as a measure of workload. *The International Journal of Aviation Psychology*, 7(2):171–182, 1997.
- [55] P. Kopardekar R. Mogford. The complexity construct in air traffic control: A review and synthesis of the literature. Report No. FAA/CT-TN95/22, 7 1995.
- [56] L.E. Staveland S.G. Hart. Development of the nasa-tlx (task load index), results of empirical and theoretical research. *Human Mental Workload*, pages 139–183, 1988.
- [57] Laerd Statistics. Kendall’s tau-b using spss statistics, 2020. URL <https://statistics.laerd.com/spss-tutorials/kendalls-tau-b-using-spss-statistics.php>. Course: Statistical tutorials and software guides.
- [58] Laerd Statistics. Pearson’s product moment correlation, 2020. URL <https://statistics.laerd.com/statistical-guides/pearson-correlation-coefficient-statistical-guide.php>. Course: Statistical tutorials and software guides.

- 
- [59] Laerd Statistics. Spearman's rank-order correlation, 2020. URL <https://statistics.laerd.com/statistical-guides/spearmans-rank-order-correlation-statistical-guide.php>. Course: Statistical tutorials and software guides.
- [60] E. Stein. Air Traffic Controller Workload: An examination of workload probe. Number Report No. DOT/FAA/CT-TN84/24. Federal Aviation Administration, Atlantic City, New Jersey, USA, 1985.
- [61] N.R. Uclés and J.N.C. García. Relation between workload and duration of atc voice communications. 6th International Conference on Research in Air Transportation (Istanbul), 06 2014.
- [62] G.B. van Baren et al. Reduced wake turbulence separation at schiphol airport. NLR Air Transport Safety Institute, 2013. Doc No. NLR-CR-2013-546.
- [63] W.B. Verwey. On-line driver workload estimation. effects of road situation and age on secondary task measures. *Ergonomics*, 43(2):187–209, 2000.
- [64] Wyndemere. An Evaluation of Air Traffic Control Complexity. Number Final Report Contract NAS2-14284. Wyndemere, Boulder, Colorado, USA, 1996.
- [65] M.S. Young and N.A. Stanton. What's skill got to do with it? vehicle automation and driver mental workload. *Human Factors: The Journal of the Human Factors and Ergonomics Society*, 30(01):111–120, 2007.